



CATA LOGUE

General

TABLE OF CONTENTS

Indoor Lighting

Modular
Leo IP
Down Light
Nero
Vega C
Mega
Pavo
Mensa Plus
Bianca
Pulsar
Peek
Ray
Elara
Spark
Step
Auriga IP20
Auriga IP67
Indoor Linear
Meteor Magnetic
Track Rail and Accessories
Pavo Track
Helene
Ponto

Design Collection Lighting

Drop
Moonline
Sleek
Glance
Orion

Outdoor Lighting

Uplight
Outdoor Linear
Drive-Over
Wall Light
Down Light
NeonFlex
Projector
Bollard

Underwater Lighting

Spot Light
Linear
NeonFlex



ACUMEN LIGHT

Has a passion for world class excellence, backed by decades of experience in lighting systems and design. With a wide variety of cutting edge lighting technologies, we know how to bring your boldest design ideas to life.

One of our core beliefs is that the power of lighting and illumination has no limits in expressing style and setting the mood for any space. The value of good lighting can completely transform familiar places breathing new life into them.

At Acumen Light, our three pillars are quality, design, and functionality. We always work hand in hand with our partners to deliver the highest quality products and services.

Our team of architects, electrical engineers, and lighting advisors is dedicated to creating innovative solutions and educating our clients to

EMBRACE THE LIGHT!





QUALITY, SUSTAINABILITY

At Acumen Light, we are more than just a company, we are a customer-focused brand dedicated to sustainability and innovation.

We continuously strive to use eco-friendly materials, resources, and equipment in our lighting systems, both before and after installation.

Our LED products consume %90 less power than traditional alternatives while maintaining exceptional quality, long lifespan, low energy consumption, and minimal maintenance. Additionally, our products can be customized to meet specific needs.

Acuemn's lighting fixtures are compatible with all major control systems, including 10-0V, 10-1V, phase dimming, and DALI providing smart, flexible lighting solutions for any application.

We believe that the future is preserved through today's actions, and sustainability in design is a core value at Acumen Light.

Our eco-friendly systems help reduce carbon footprints, ensuring higher efficiency and superior performance across all applications.

We take pride in our internally developed products, designed to save energy and reduce costs for our clients, without compromising on quality.



SERVICES, BENEFITS

Our services are focused on creating atmosphere and ambiance while ensuring the practical application of light. Lighting should not only be seen as a functional solution but also as an essential element of the overall experience. At Acumen Light, we embrace the challenge of transforming bold ideas into practical, real-world solutions, keeping in mind that every space is unique.

We collaborate with international manufacturers to source the best LED chips and LED drivers, ensuring efficient lighting production that guarantees smooth and trouble-free operations.

Additionally, we are proud to offer a 5-year warranty on our impressive range of LED light products, ensuring both efficiency and performance.

We provide full support to our clients to ensure quality throughout all phases of the project. Our team studies the client's desired lifestyle, supplies the necessary fixtures and accessories, and supervises the installation process to guarantee complete client satisfaction.



ACUMEN indoor lighting enhances the interior environment of any home. With a wide variety of styles and shapes, our lighting fixtures provide excellent illumination while creating a comfortable atmosphere.

Our diverse range of lighting types—such as spotlights, wall washers, pendant and track light systems, recessed and surface-mounted downlights—perfectly complements any interior design.

The best lighting solutions conserve energy, and while LED light sources offer high luminance levels, they can sometimes cause glare.

To address this, ACUMEN LED fixtures are often equipped with anti-glare accessories and lenses to minimize this uncomfortable visual effect.



MODULAR

ACUMEN Modular LED light fixtures can fit any environment and can serve as an ambient, task, or accent lighting type. A variety of beam angles, frame types, and colors will compliment any interior design. For a more comfortable atmosphere, there are anti-glare accessories and dimming options available. The wattage

- DRIVERS ARE PROVIDED BY **TRIDONIC**

Narrow Beam Angle

ACU 01703-09

RTL

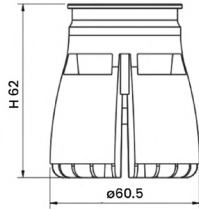

Wattage	Beam Angle
9W	10°
Color Temperature	Lumen Output
3000K	750 LM
Operation Temperature	Rated Life Hours
-20°C~+40°C	30,000 - 50,000H
Installation	Input Voltage
Recessed	220V AC (Via the Attached Remote Driver)
Accessory	CRI
Honey Comb 	≥ 90

ACU 01703-15

RTL

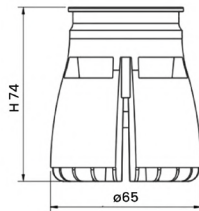

Wattage	Beam Angle
15W	10°
Color Temperature	Lumen Output
3000K	1100 LM
Operation Temperature	Rated Life Hours
-20°C~+40°C	30,000 - 50,000H
Installation	Input Voltage
Recessed	220V AC (Via the Attached Remote Driver)
Accessory	CRI
Honey Comb 	≥ 90

Narrow Beam Angle

ACU 01704-09

RTL

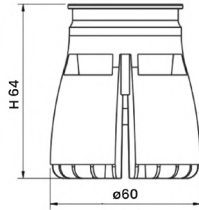

Wattage	Beam Angle
---------	------------

9W	15° 25° 40° 60°
----	-----------------

Color Temperature	Lumen Output
-------------------	--------------

3000K	750 LM
-------	--------

Operation Temperature	Rated Life Hours
-----------------------	------------------

-20°C~+40°C	30,000 - 50,000H
-------------	------------------

Installation	Input Voltage
--------------	---------------

Recessed	220V AC (Via the Attached Remote Driver)
----------	---

Accessory	CRI
-----------	-----

Honey Comb 	≥ 90
---	------

ACU 01704-15

RTL

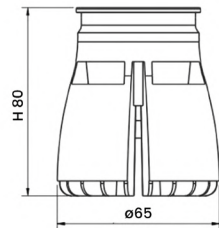

Wattage	Beam Angle
---------	------------

15W	15° 25° 40° 60°
-----	-----------------

Color Temperature	Lumen Output
-------------------	--------------

3000K	1100 LM
-------	---------

Operation Temperature	Rated Life Hours
-----------------------	------------------

-20°C~+40°C	30,000 - 50,000H
-------------	------------------

Installation	Input Voltage
--------------	---------------

Recessed	220V AC (Via the Attached Remote Driver)
----------	---

Accessory	CRI
-----------	-----

Honey Comb 	≥ 90
---	------



THE FRAMES

Stella Adjustable, Libra, Hydra Collection, Lynex, and Cursa.
All these product frames are available in multiple color options to suit a variety of styles and design preferences!

- Black / Black
- White / Silver
- ▣ White / Black
- ◼ White / Gold
- White / White
- ◼ Black / Gold

ACU 10002 ADJ
Stella Adj

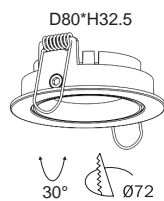

ACU 10004
LIBRA

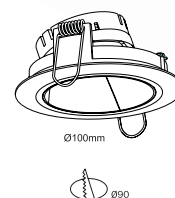

FRAMES

Modular

ACU 10005R
HYDRA

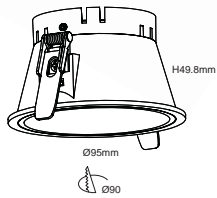

ACU 10005RW
HYDRA

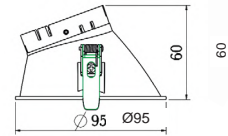

ACU 10005S
HYDRA-SQUARE

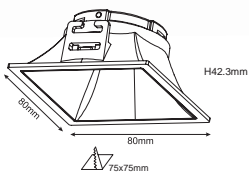
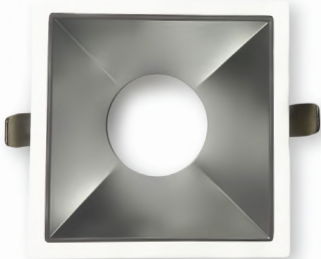

10005SW
HYDRA-SQUARE

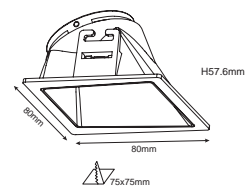
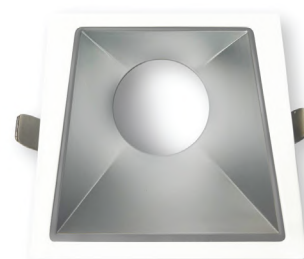

FRAMES

Modular

ACU 10006R

LYNX

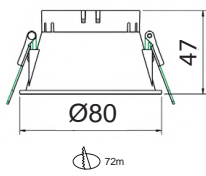

ACU 10006RW

LYNX

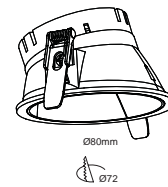

ACU 10007DS

CURSA

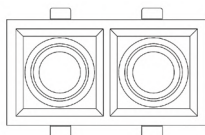

LEO-IP

A recessed spotlight made of powder-coated aluminium housing with excellent heat sink capability to minimize luminous degradation. This light is recommended to be used in wet applications such as washrooms.

- DRIVERS ARE PROVIDED BY **TRIDONIC**



LEO IP

Round Frame

ACU S 17009

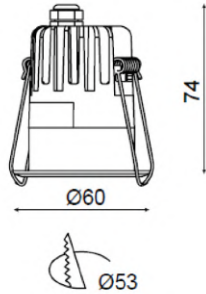

Wattage	Beam Angle
---------	------------

8W	20° 24° 36°
----	-------------

Color Temperature	Lumen Output
-------------------	--------------

3000k	675 Lm
-------	--------

Installation	Rated Life Hours
--------------	------------------

Recessed	30,000 - 50,000H
----------	------------------

CRI	Colors
-----	--------

≥90	■ Black □ White
-----	-----------------

Input Voltage	Material
---------------	----------

220V AC (Via the Attached Remote Driver)	Aluminum
---	----------

Cutting Section

Cut out Ø53mm



ACU S 17010

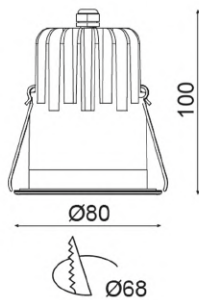

Wattage	Beam Angle
---------	------------

15W	15° 24° 38° 60°
-----	-----------------

Color Temperature	Lumen Output
-------------------	--------------

3000k	1125 Lm
-------	---------

Installation	Rated Life Hours
--------------	------------------

Recessed	30,000 - 50,000H
----------	------------------

CRI	Colors
-----	--------

≥90	■ Black □ White
-----	-----------------

Input Voltage	Material
---------------	----------

220V AC (Via the Attached Remote Driver)	Aluminum
---	----------

Cutting Section

Cut out Ø68mm





LEO IP

Adjustable

ACU S 17010 ADJ

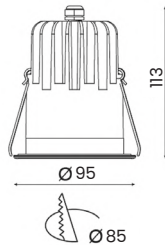

Wattage

15W

Beam Angle

15° 24° 38° 60°

Color Temperature

3000k

Lumen Output

1125 Lm

Installation

Recessed

Rated Life Hours

30,000 - 50,000H

CRI

≥90

Colors

■ Black □ White

Input Voltage

220V AC
(Via the Attached Remote Driver)

Material

Aluminum

Cutting Section

Cut out Ø85 mm



LEO IP

Mini Round Frame

ACU S 17010MR

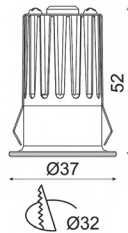

Wattage

15W

Beam Angle

10°

Color Temperature

3000k

Lumen Output

90 Lm

Installation

Recessed

Rated Life Hours

30,000 - 50,000H

CRI

≥90

Colors

■ Black □ White

Input Voltage

220V AC
(Via the Attached Remote Driver)

Material

Aluminum

Cutting Section

Cut out Ø32 mm



DOWN LIGHT

The range of variety of the **Down Light** categories makes it irresistible to use. As users can find different wattages, color temperature, and beam angles, as well as different types, from the recessed surface, mounted, to suspended downlights.

Down Light families will allow the users to use them in their multiple applications.

NERO COLLECTION



Nero Black Hole

This lighting solution is engineered to precisely focus light and distribute it evenly, ensuring both functional and aesthetic illumination. Featuring a small aperture design combined with cross-lighting technology, it minimizes direct glare while enhancing ambient brightness. The fixture delivers low glare performance and boasts high luminous efficiency, reaching up to 70%, making it an ideal choice for energy-efficient and visually comfortable lighting applications.

Nero FLAT

ACU FS 251101

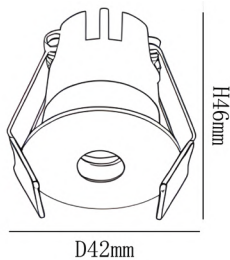

Wattage	Beam Angle
5W	15° 36°
Color Temperature	Lumen Output
3000k	300 Lm
Installation	Rated Life Hours
Recessed	30,000 - 50,000H
CRI	Colors
≥90	■ Black □ White
Input Voltage	Material
220V AC (Via the Attached Remote Driver)	Powder Coated Aluminum
Cutting Section	
Cut out Ø35 mm	



Flat Shape Frame

Nero Collection

ACU FS 251102

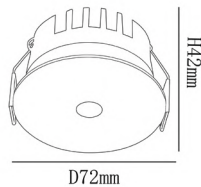

Wattage	Beam Angle
10W	15° 36°
Color Temperature	Lumen Output
3000k	600 Lm
Installation	Rated Life Hours
Recessed	30,000 - 50,000H
CRI	Colors
≥90	■ Black □ White
Input Voltage	Material
220V AC (Via the Attached Remote Driver)	Powder Coated Aluminum
Cutting Section	
Cut out Ø65 mm	



ACU FS 251103

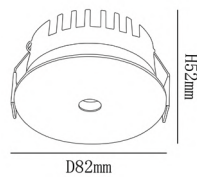

Wattage	Beam Angle
5W	15° 36°
Color Temperature	Lumen Output
3000k	900 Lm
Installation	Rated Life Hours
Recessed	30,000 - 50,000H
CRI	Colors
≥90	■ Black □ White
Input Voltage	Material
220V AC (Via the Attached Remote Driver)	Powder Coated Aluminum
Cutting Section	
Cut out Ø75 mm	







Nero **CURVED**

Adjustable Curved Shape Frame

Nero Collection

ACU CS 251000

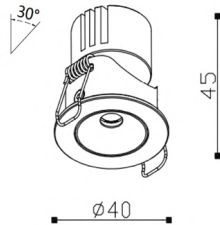

Wattage	Beam Angle
---------	------------

5W	25° 40°
----	---------

Color Temperature	Lumen Output
-------------------	--------------

3000k	172 Lm
-------	--------

Installation	Rated Life Hours
--------------	------------------

Recessed	30,000 - 50,000H
----------	------------------

CRI	Colors
-----	--------

≥95	<input checked="" type="checkbox"/> Black <input type="checkbox"/> White
-----	--

Input Voltage	Material
---------------	----------

220V AC (Via the Attached Remote Driver)	Powder Coated Aluminum
---	------------------------

Cutting Section

Cut out Ø35 mm



ACU CS 251001

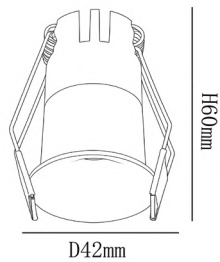

Wattage	Beam Angle
---------	------------

5W	15° 36°
----	---------

Color Temperature	Lumen Output
-------------------	--------------

3000k	300 Lm
-------	--------

Installation	Rated Life Hours
--------------	------------------

Recessed	30,000 - 50,000H
----------	------------------

CRI	Colors
-----	--------

≥90	<input checked="" type="checkbox"/> Black <input type="checkbox"/> White
-----	--

Input Voltage	Material
---------------	----------

220V AC (Via the Attached Remote Driver)	Powder Coated Aluminum
---	------------------------

Cutting Section

Cut out Ø35 mm



Adjustable Curved Shape Frame

Nero Collection

ACU CS 251002

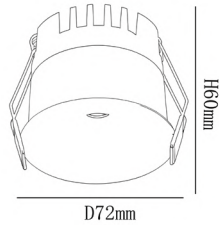

Wattage	Beam Angle
10W	15° 36°
Color Temperature	Lumen Output
3000k	600 Lm
Installation	Rated Life Hours
Recessed	30,000 - 50,000H
CRI	Colors
≥95	■ Black □ White
Input Voltage	Material
220V AC (Via the Attached Remote Driver)	Powder Coated Aluminum
Cutting Section	
Cut out Ø85 mm	



ACU CS 251003

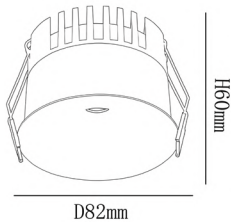

Wattage	Beam Angle
15W	15° 36°
Color Temperature	Lumen Output
3000k	900 Lm
Installation	Rated Life Hours
Recessed	30,000 - 50,000H
CRI	Colors
≥90	■ Black □ White
Input Voltage	Material
220V AC (Via the Attached Remote Driver)	Powder Coated Aluminum
Cutting Section	
Cut out Ø75 mm	





Nero TRIMLESS



ACU TS 251201

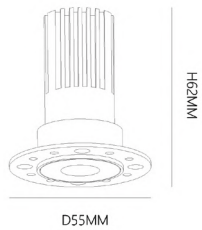

Wattage	Beam Angle
5W	15° 36°
Color Temperature	Lumen Output
3000k	350 Lm
Installation	Rated Life Hours
Recessed	30,000 - 50,000H
CRI	Colors
≥90	■ Black □ White
Input Voltage	Material
220V AC (Via the Attached Remote Driver)	Powder Coated Aluminum
Cutting Section	
Cut out Ø35mm	



Nero Trimless Frame

Nero Collection

ACU TS 251202

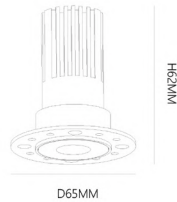

Wattage	Beam Angle
10W	15° 36°
Color Temperature	Lumen Output
3000k	700 Lm
Installation	Rated Life Hours
Recessed	30,000 - 50,000H
CRI	Colors
≥95	■ Black □ White
Input Voltage	Material
220V AC (Via the Attached Remote Driver)	Powder Coated Aluminum
Cutting Section	
Cut out Ø45 mm	



ACU TS 251203

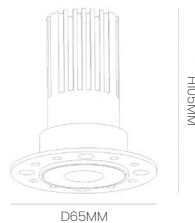

Wattage	Beam Angle
15W	15° 36°
Color Temperature	Lumen Output
3000k	1050 Lm
Installation	Rated Life Hours
Recessed	30,000 - 50,000H
CRI	Colors
≥90	■ Black □ White
Input Voltage	Material
220V AC (Via the Attached Remote Driver)	Powder Coated Aluminum
Cutting Section	
Cut out Ø45 mm	





Nero WALL WASHER

ACU WW 251301

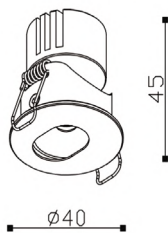

Wattage	Beam Angle
5W	15° 38°
Color Temperature	Lumen Output
3000k	350 Lm
Installation	Rated Life Hours
Recessed	30,000 - 50,000H
CRI	Colors
≥95	■ Black □ White
Input Voltage	Material
220V AC (Via the Attached Remote Driver)	Powder Coated Aluminum
Cutting Section	
Cut out Ø35mm	



VEGA C

LED ultra-thin downlight design is handy, simple, and easy to install. The anti-glare system provides visual comfort for the user. This light comes with a frosted acrylic diffuser for high light transmittance.

- DRIVERS ARE PROVIDED BY **TRIDONIC**





Recessed Down Light

ACU D 20060

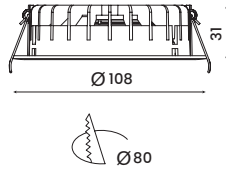

Wattage	Beam Angle
5W	100°
Color Temperature	Lumen Output
3000K	400 LM
Operation Temperature	Rated Life Hours
-20°C~+40°C	30,000 - 50,000H
Installation	Input Voltage
Recessed	220V AC (Via the Attached Remote Driver)
CRI	
≥ 90	



ACU D 20061

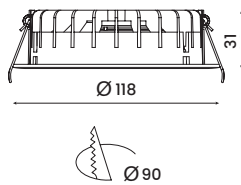

Wattage	Beam Angle
7W	100°
Color Temperature	Lumen Output
3000K	560 LM
Operation Temperature	Rated Life Hours
-20°C~+40°C	30,000 - 50,000H
Installation	Input Voltage
Recessed	220V AC (Via the Attached Remote Driver)
CRI	
≥ 90	



Recessed Down Light

ACU D 20062

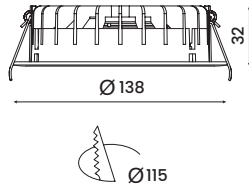

Wattage	Beam Angle
9W	100°
Color Temperature	Lumen Output
3000K	720 LM
Operation Temperature	Rated Life Hours
-20°C~+40°C	30,000 - 50,000H
Installation	Input Voltage
Recessed	220V AC (Via the Attached Remote Driver)
CRI	
≥ 90	



ACU D 20063

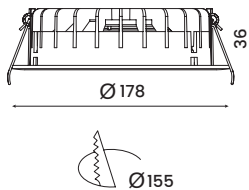

Wattage	Beam Angle
12W	100°
Color Temperature	Lumen Output
3000K	960 LM
Operation Temperature	Rated Life Hours
-20°C~+40°C	30,000 - 50,000H
Installation	Input Voltage
Recessed	220V AC (Via the Attached Remote Driver)
CRI	
≥ 90	



Recessed Down Light

ACU D 20064

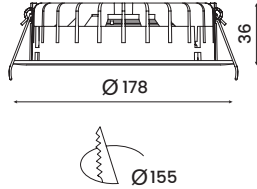

Wattage	Beam Angle
---------	------------

15W	100°
-----	------

Color Temperature	Lumen Output
-------------------	--------------

3000K	1200 LM
-------	---------

Operation Temperature	Rated Life Hours
-----------------------	------------------

-20°C~+40°C	30,000 - 50,000H
-------------	------------------

Installation	Input Voltage
--------------	---------------

Recessed	220V AC (Via the Attached Remote Driver)
----------	---

CRI

≥ 90



ACU D 20065

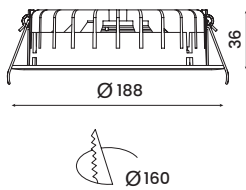

Wattage	Beam Angle
---------	------------

20W	100°
-----	------

Color Temperature	Lumen Output
-------------------	--------------

3000K	1600 LM
-------	---------

Operation Temperature	Rated Life Hours
-----------------------	------------------

-20°C~+40°C	30,000 - 50,000H
-------------	------------------

Installation	Input Voltage
--------------	---------------

Recessed	220V AC (Via the Attached Remote Driver)
----------	---

CRI

≥ 90



Recessed Down Light

ACU D 20066

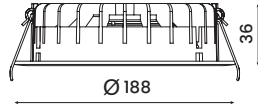

Wattage	Beam Angle
25W	100°
Color Temperature	Lumen Output
3000K	2000 LM
Operation Temperature	Rated Life Hours
-20°C~+40°C	30,000 - 50,000H
Installation	Input Voltage
Recessed	220V AC (Via the Attached Remote Driver)
CRI	
≥ 90	



ACU D 20067

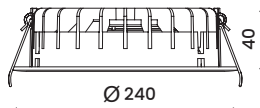

Wattage	Beam Angle
20W	100°
Color Temperature	Lumen Output
3000K	1600 LM
Operation Temperature	Rated Life Hours
-20°C~+40°C	30,000 - 50,000H
Installation	Input Voltage
Recessed	220V AC (Via the Attached Remote Driver)
CRI	
≥ 90	



MEGA

LED ultra-thin downlight design is handy, simple, and easy to install. The anti-glare system provides visual comfort for the user. This light comes with a frosted acrylic diffuser for high light transmittance.

- DRIVERS ARE PROVIDED BY **TRIDONIC**





Recessed Down Light

ACU DR 240001

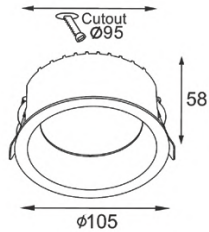

Wattage	Beam Angle
15W	85°
Color Temperature	Lumen Output
3000K	1423 LM
Operation Temperature	Rated Life Hours
-20°C~+40°C	30,000 - 50,000H
CRI	Colors
≥90	■ Black □ White
Input Voltage	Installation
220V AC (Via the Attached Remote Driver)	Recessed



ACU DR 240002

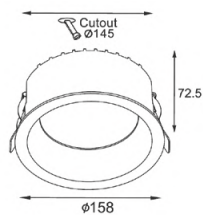

Wattage	Beam Angle
33W	85°
Color Temperature	Lumen Output
3000K	3532 LM
Operation Temperature	Rated Life Hours
-20°C~+40°C	30,000 - 50,000H
CRI	Colors
≥90	■ Black □ White
Input Voltage	Installation
220V AC (Via the Attached Remote Driver)	Recessed



Surface Mounted Down Light

ACU DSM 240003

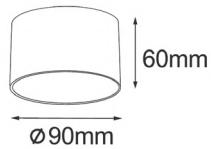

Wattage	Beam Angle
---------	------------

8W	80°
----	-----

Color Temperature	Lumen Output
-------------------	--------------

3000K	635 LM
-------	--------

Operation Temperature	Rated Life Hours
-----------------------	------------------

-20°C~+40°C	30,000 - 50,000H
-------------	------------------

CRI	Colors
-----	--------

≥90	<input type="checkbox"/> Black/Black <input type="checkbox"/> White/Gold <input type="checkbox"/> White/White <input type="checkbox"/> White/Silver
-----	--

Input Voltage	Installation
---------------	--------------

220V AC (Via the Attached Remote Driver)	Surface Mounted
---	-----------------



ACU DSM 240004

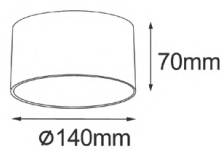

Wattage	Beam Angle
---------	------------

15W	80°
-----	-----

Color Temperature	Lumen Output
-------------------	--------------

3000K	1139 LM
-------	---------

Operation Temperature	Rated Life Hours
-----------------------	------------------

-20°C~+40°C	30,000 - 50,000H
-------------	------------------

CRI	Colors
-----	--------

≥90	<input type="checkbox"/> Black/Black <input type="checkbox"/> White/Gold <input type="checkbox"/> White/White <input type="checkbox"/> White/Silver
-----	--

Input Voltage	Installation
---------------	--------------

220V AC (Via the Attached Remote Driver)	Surface Mounted
---	-----------------





Surface Mounted Down Light

ACU DSM 240005

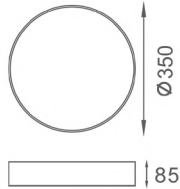

Wattage	Beam Angle
---------	------------

30W	110°
-----	------

Color Temperature	Lumen Output
-------------------	--------------

3000K	3160 LM
-------	---------

Operation Temperature	Rated Life Hours
-----------------------	------------------

-20°C~+40°C	30,000 - 50,000H
-------------	------------------

CRI	Colors
-----	--------

≥90	■ Black/Black ■ White/Gold □ White/White □ White/Silver
-----	--

Input Voltage	Installation
---------------	--------------

220V AC (Via the Attached Remote Driver)	Surface Mounted
---	-----------------





PAVO

This family is specialized in residential and hospitality applications because of its high efficiency, variety of beam angles, and wattages. The main character of this family is that it is adjustable, which supports the users in illuminating different surfaces from one source.

- DRIVERS ARE PROVIDED BY **TRIDONIC**

Pavo

Pavo Adjustable

ACU 200901

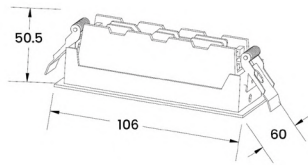
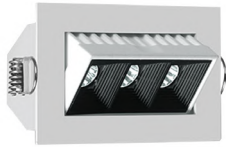

Wattage	Beam Angle
3x2W	12° 34° 48°
Color Temperature	Lumen Output
3000k	450 Lm
Installation	Rated Life Hours
Recessed	30,000 - 50,000H
CRI	Colors
≥90	<input type="checkbox"/> White
Input Voltage	Material
220V AC (Via the Attached Remote Driver)	Powder Coated Aluminum
Dimension	Cutting Section
L 106 x W 60 x H 50.5 mm	Cut out L 97 x W49 mm



ACU 200902

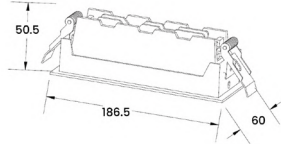

Wattage	Beam Angle
6x2W	12° 24° 34° 48°
Color Temperature	Lumen Output
3000k	900 Lm
Installation	Rated Life Hours
Recessed	30,000 - 50,000H
CRI	Colors
≥90	<input checked="" type="checkbox"/> Black <input type="checkbox"/> White
Input Voltage	Material
220V AC (Via the Attached Remote Driver)	Powder Coated Aluminum
Dimension	Cutting Section
L 186.5 x W 60 x H 50.5mm	Cut out L 180 x W50 mm



Pavo

Pavo Wall Washer

ACU 200903

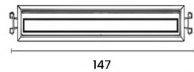
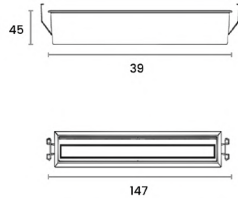
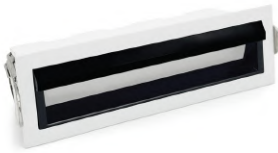

Wattage	5x2W	Beam Angle	100°
Color Temperature	3000k	Lumen Output	750 Lm
Installation	Recessed	Rated Life Hours	30,000 - 50,000H
CRI	≥90	Colors	<input type="checkbox"/> White
Input Voltage	220V AC (Via the Attached Remote Driver)	Material	Powder Coated Aluminum
Dimension	L 147 x W 45 x H 39 mm	Cutting Section	Cut out L 132 x W36 mm



ACU 200904

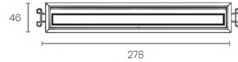

Wattage	10x2W	Beam Angle	100°
Color Temperature	3000k	Lumen Output	1500 Lm
Installation	Recessed	Rated Life Hours	30,000 - 50,000H
CRI	≥90	Colors	<input checked="" type="checkbox"/> Black <input type="checkbox"/> White
Input Voltage	220V AC (Via the Attached Remote Driver)	Material	Powder Coated Aluminum
Dimension	L 278 x W 46 x H 36 mm	Cutting Section	Cut out L 269 x W36 mm





Pavo

Pavo Wall Washer

ACU 200905

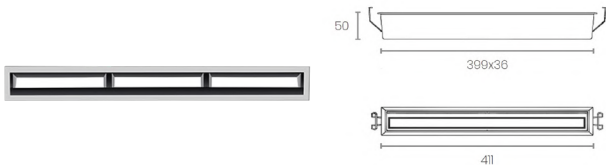

Wattage	15x2W	Beam Angle	100°
Color Temperature	3000k	Lumen Output	2580 Lm
Installation	Recessed	Rated Life Hours	30,000 - 50,000H
CRI	≥90	Colors	<input type="checkbox"/> White
Input Voltage	220V AC (Via the Attached Remote Driver)	Material	Powder Coated Aluminum
Dimension	L 411 x W 36 x H 50 mm	Cutting Section	Cut out L 399 x W 36 mm



Pavo

Pavo DownLight

ACU S 18104

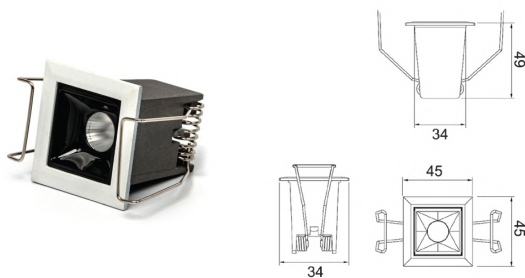

Wattage	10x2W	Beam Angle	12° 30°
Color Temperature	3000k	Lumen Output	185 Lm
Installation	Recessed	Rated Life Hours	30,000 - 50,000H
CRI	≥90	Colors	<input checked="" type="checkbox"/> Black <input type="checkbox"/> White
Input Voltage	220V AC (Via the Attached Remote Driver)	Material	Powder Coated Aluminum
Dimension	L 45 x W 45 x H 49 mm	Cutting Section	Cut out L 34 x W 34 mm



Pavo

Pavo DownLight

ACU S 18105

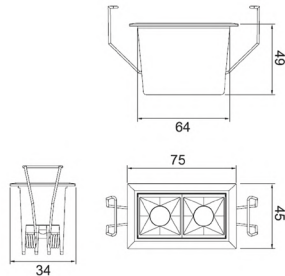

Wattage	2x2W	Beam Angle	12° 30°
Color Temperature	3000k	Lumen Output	370 Lm
Installation	Recessed	Rated Life Hours	30,000 - 50,000H
CRI	≥90	Colors	<input type="checkbox"/> White
Input Voltage	220V AC (Via the Attached Remote Driver)	Material	Powder Coated Aluminum
Dimention	L 75 x W 45 x H 49 mm	Cutting Section	Cut out L 68 x W37 mm



Pavo

Pavo DownLight

ACU S 18106

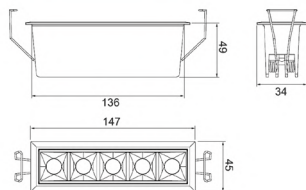

Wattage	5x2W	Beam Angle	12° 30°
Color Temperature	3000k	Lumen Output	825 Lm
Installation	Recessed	Rated Life Hours	30,000 - 50,000H
CRI	≥90	Colors	<input checked="" type="checkbox"/> Black <input type="checkbox"/> White
Input Voltage	220V AC (Via the Attached Remote Driver)	Material	Powder Coated Aluminum
Dimention	L 147x W 45x H 49 mm	Cutting Section	Cut out L 140 x W 37 mm





Pavo

Pavo DownLight

ACU S 18107

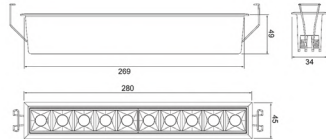

Wattage	10x2 W	Beam Angle	12° 30°
Color Temperature	3000k	Lumen Output	1850 Lm
Installation	Recessed	Rated Life Hours	30,000 - 50,000H
CRI	≥90	Colors	■ Black □ White
Input Voltage	220V AC (Via the Attached Remote Driver)	Material	Powder Coated Aluminum
Dimention	L 280 x W 45 x H 49 mm	Cutting Section	Cut out L 273 x W37 mm



Pavo

Pavo DownLight

ACU S 18108

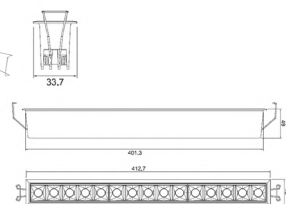

Wattage	15x2 W	Beam Angle	12° 30°
Color Temperature	3000k	Lumen Output	2775 Lm
Installation	Recessed	Rated Life Hours	30,000 - 50,000H
CRI	≥90	Colors	□ White
Input Voltage	220V AC (Via the Attached Remote Driver)	Material	Powder Coated Aluminum
Dimention	L 412.7 x W 45 x H 49 mm	Cutting Section	Cut out L 401.3 x W33.7 mm



MENSA PLUS

Adjustable spotlight is designed for sophisticated accent lighting—perfectly highlighting art, textures, and architectural beauty. A seamless blend of form and function for discerning interiors.



RECESSED ADJUSTABLE SPOT LIGHT

Mensa Plus

ACU RL 245010

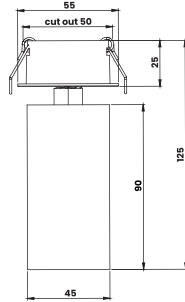

Wattage	Beam Angle
7W	15° 24° 38°
Color Temperature	Lumen Output
3000k	560 Lm
Installation	Rated Life Hours
Recessed	30,000 - 50,000H
CRI	Colors
≥90	■ Black □ White
Input Voltage	Material
220V AC (Via the Attached Remote Driver)	Aluminum



RECESSED SPOT LIGHT

Mensa Plus

ACU RL 245011

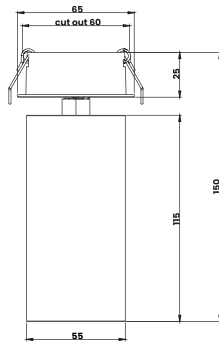

Wattage	Beam Angle
15W	15° 24° 38°
Color Temperature	Lumen Output
3000k	1200 Lm
Installation	Rated Life Hours
Recessed	30,000 - 50,000H
CRI	Colors
≥90	■ Black □ White
Input Voltage	Material
220V AC (Via the Attached Remote Driver)	Aluminum



RECESSED SPOT LIGHT

Mensa Plus

ACU RL 245012

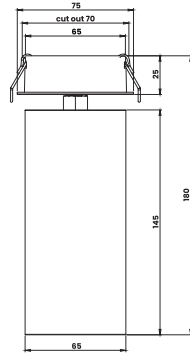

Wattage

24W

Beam Angle

15° 24° 38°

Color Temperature

3000k

Lumen Output

2040 Lm

Installation

Recessed

Rated Life Hours

30,000 - 50,000H

CRI

≥90

Colors

■ Black □ White

Input Voltage

220V AC
(Via the Attached Remote Driver)

Material

Aluminum





SURFACE MOUNTED ADJUSTABLE SPOT LIGHT

Mensa Plus

ACU SML 245510

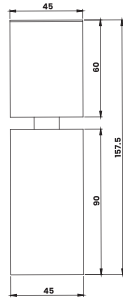

Wattage	Beam Angle
7W	15° 24° 38°
Color Temperature	Lumen Output
3000k	560 Lm
Installation	Rated Life Hours
Surface Mounted	30,000 - 50,000H
CRI	Colors
≥90	■ Black □ White
Input Voltage	Material
220V AC (Via the Attached Remote Driver)	Aluminum



SURFACE MOUNTED SPOT LIGHT

Mensa Plus

ACU SML 245511

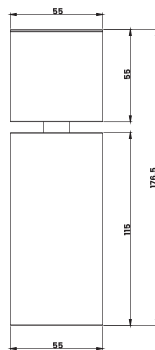

Wattage	Beam Angle
15W	15° 24° 38°
Color Temperature	Lumen Output
3000k	1200 Lm
Installation	Rated Life Hours
Surface Mounted	30,000 - 50,000H
CRI	Colors
≥90	■ Black □ White
Input Voltage	Material
220V AC (Via the Attached Remote Driver)	Aluminum



SURFACE MOUNTED SPOT LIGHT

Mensa Plus

ACU SML 245512

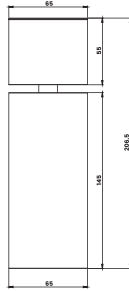

Wattage

24W

Beam Angle

15° 24° 38°

Color Temperature

3000k

Lumen Output

2040 Lm

Installation

Surface Mounted

Rated Life Hours

30,000 - 50,000H

CRI

≥90

Colors

■ Black □ White

Input Voltage

220V AC
(Via the Attached Remote Driver)

Material

Aluminum





אור
אור
אור

TRACK MOUNTED ADJUSTABLE SPOT LIGHT

Mensa Plus

ACU TL 244010

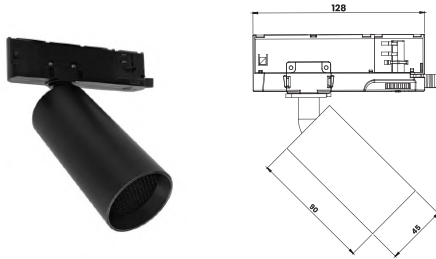

Wattage	Beam Angle
7W	15° 24° 38°
Color Temperature	Lumen Output
3000k	560 Lm
Installation	Rated Life Hours
Track Mounted	30,000 - 50,000H
CRI	Colors
≥90	■ Black □ White
Input Voltage	Material
220V AC (Via the Attached Remote Driver)	Aluminum



TRACK MOUNTED SPOT LIGHT

Mensa Plus

ACU TL 244011

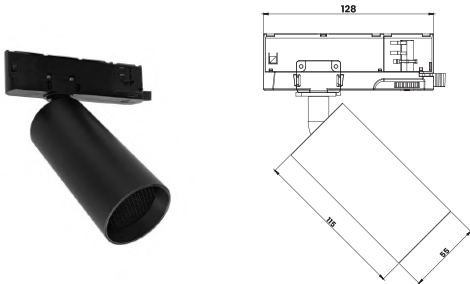

Wattage	Beam Angle
15W	15° 24° 38°
Color Temperature	Lumen Output
3000k	1200 Lm
Installation	Rated Life Hours
Track Mounted	30,000 - 50,000H
CRI	Colors
≥90	■ Black □ White
Input Voltage	Material
220V AC (Via the Attached Remote Driver)	Aluminum



TRACK MOUNTED ADJUSTABLE SPOT LIGHT

Mensa Plus

ACU TL 244012

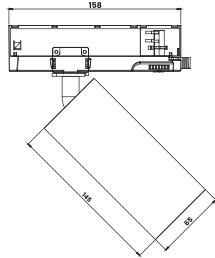

Wattage

24W

Beam Angle

15° 24° 38°

Color Temperature

3000k

Lumen Output

2040 Lm

Installation

Track Mounted

Rated Life Hours

30,000 - 50,000H

CRI

≥90

Colors

■ Black □ White

Input Voltage

220V AC
(Via the Attached Remote Driver)

Material

Aluminum





BIANCA

Adjustable spotlight is designed for sophisticated accent lighting—perfectly highlighting art, textures, and architectural beauty. A seamless blend of form and function for discerning interiors.



Bianca

Surface mounted

ACU 200101

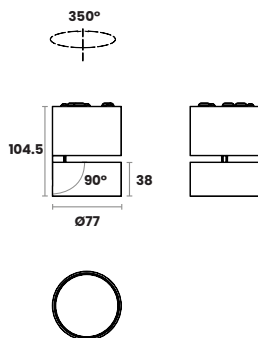

Wattage

13W

Beam Angle

12° 25° 38°

Color Temperature

3000k

Lumen Output

1079 Lm

Installation

Surface mounted

Rated Life Hours

30,000 - 50,000H

CRI

≥90

Colors

■ Black □ White

Input Voltage

220V AC
(Via the Attached Remote Driver)

Material

Powder Coated
Aluminium



Bianca

Recessed

ACU 200102

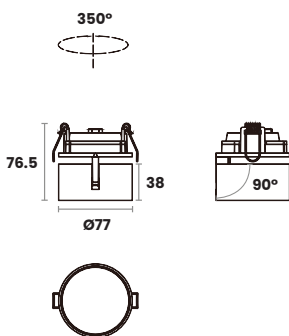

Wattage

13W

Beam Angle

12° 25° 38°

Color Temperature

3000k

Lumen Output

1079 Lm

Installation

Recessed

Rated Life Hours

30,000 - 50,000H

CRI

≥90

Colors

■ Black □ White

Input Voltage

220V AC
(Via the Attached Remote Driver)

Material

Powder Coated
Aluminium

Cutting Section

Cut out Ø72 mm





PULSAR

Mini Spot Light

Mini spotlight provides discreet yet powerful accent lighting—ideal for enhancing textures, artworks, and architectural features with subtle sophistication.



Pulsar

Single Adjustable Spot Light

ACU 28101

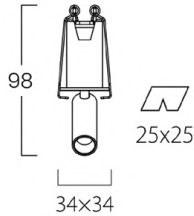

Wattage	Beam Angle
---------	------------

2W	15° 24°
----	---------

Color Temperature	Lumen Output
-------------------	--------------

3000k	96 Lm
-------	-------

Installation	Rated Life Hours
--------------	------------------

Recessed	30,000 - 50,000H
----------	------------------

CRI	Colors
-----	--------

≥90	■ Black □ White
-----	-----------------

Input Voltage	Material
---------------	----------

220V AC (Via the Attached Remote Driver)	Die Casting Aluminium
---	-----------------------

Cutting Section

Cut out 25 x 25 mm



Pulsar

Triple Adjustable Spot light

ACU 28102

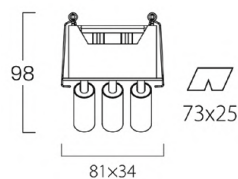

Wattage	Beam Angle
---------	------------

3x2W	15° 24°
------	---------

Color Temperature	Lumen Output
-------------------	--------------

3000k	384 Lm
-------	--------

Installation	Rated Life Hours
--------------	------------------

Surface Mounted	30,000 - 50,000H
-----------------	------------------

CRI	Colors
-----	--------

≥90	■ Black □ White
-----	-----------------

Input Voltage	Material
---------------	----------

220V AC (Via the Attached Remote Driver)	Die Casting Aluminium
---	-----------------------

Cutting Section

Cut out 73 x 25 mm



PEEK COLLECTION

PS. Drivers are included with the lights for all operational functions.



Peek Series

Adjustable Spot Light

ACU 230001

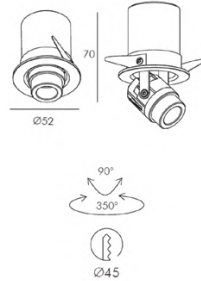
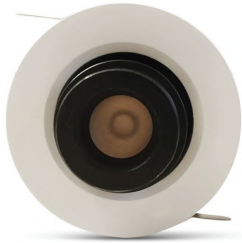

Wattage	Beam Angle
---------	------------

3W	15° 24°
----	---------

Color Temperature	Lumen Output
-------------------	--------------

3000k	148 Lm
-------	--------

Installation	Rated Life Hours
--------------	------------------

Recessed	30,000 - 50,000H
----------	------------------

CRI	Colors
-----	--------

≥90	<input checked="" type="checkbox"/> Black <input type="checkbox"/> White
-----	--

Input Voltage	Material
---------------	----------

220V AC (Via the Attached Remote Driver)	Die Casting Aluminium
---	-----------------------

Cutting Section

Cut out Ø 42 mm



ACU 230002

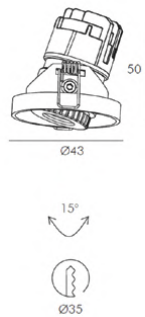

Wattage	Beam Angle
---------	------------

3W	15° 24°
----	---------

Color Temperature	Lumen Output
-------------------	--------------

3000k	65 Lm - 78Lm
-------	--------------

Installation	Rated Life Hours
--------------	------------------

Surface Mounted	30,000 - 50,000H
-----------------	------------------

CRI	Colors
-----	--------

≥90	<input checked="" type="checkbox"/> Black <input type="checkbox"/> White
-----	--

Input Voltage	Material
---------------	----------

220V AC (Via the Attached Remote Driver)	Die Casting Aluminium
---	-----------------------

Cutting Section

Cut out Ø 35 mm





Peek Series

Adjustable Spot Light

ACU 230003

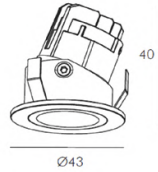

Wattage	Beam Angle
---------	------------

3W	15° 24°
----	---------

Color Temperature	Lumen Output
-------------------	--------------

3000k	108 Lm
-------	--------

Installation	Rated Life Hours
--------------	------------------

Recessed	30,000 - 50,000H
----------	------------------

CRI	Colors
-----	--------

≥90	<input checked="" type="checkbox"/> Black <input type="checkbox"/> White
-----	--

Input Voltage	Material
---------------	----------

220V AC (Via the Attached Remote Driver)	Die Casting Aluminium
---	-----------------------

Cutting Section

Cut out Ø 35 mm



ACU 230004

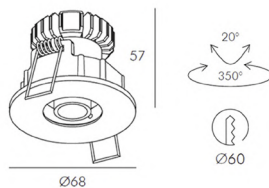

Wattage	Beam Angle
---------	------------

3W	8°
----	----

Color Temperature	Lumen Output
-------------------	--------------

3000k	128 Lm
-------	--------

Installation	Rated Life Hours
--------------	------------------

Surface Mounted	30,000 - 50,000H
-----------------	------------------

CRI	Colors
-----	--------

≥90	<input checked="" type="checkbox"/> Black <input type="checkbox"/> White
-----	--

Input Voltage	Material
---------------	----------

220V AC (Via the Attached Remote Driver)	Die Casting Aluminium
---	-----------------------

Cutting Section

Cut out Ø 60 mm



Peek Series

Adjustable Spot Light

ACU 230005

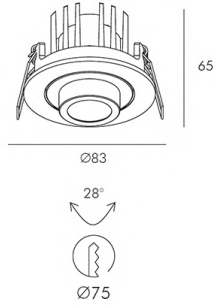

Wattage	Beam Angle
---------	------------

5W	5°
----	----

Color Temperature	Lumen Output
-------------------	--------------

3000k	143 Lm
-------	--------

Installation	Rated Life Hours
--------------	------------------

Recessed	30,000 - 50,000H
----------	------------------

CRI	Colors
-----	--------

≥90	■ Black □ White
-----	-----------------

Input Voltage	Material
---------------	----------

220V AC (Via the Attached Remote Driver)	Die Casting Aluminium
---	-----------------------

Cutting Section

Cut out Ø 75 mm



RAY COLLECTION

PS. Drivers are included with the lights for all operational functions.



Ray Series

Adjustable with Round Frame

ACU 232001

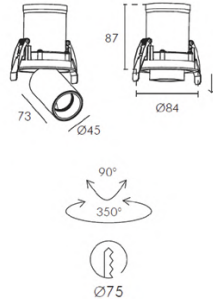

Wattage	Beam Angle
---------	------------

7W	15° 35°
----	---------

Color Temperature	Lumen Output
-------------------	--------------

3000k	395 Lm
-------	--------

Installation	Rated Life Hours
--------------	------------------

Recessed	30,000 - 50,000H
----------	------------------

CRI	Material
-----	----------

≥90	Die Casting Aluminium
-----	-----------------------

Input Voltage	
---------------	--

220V AC (Via the Attached Remote Driver)	<input checked="" type="checkbox"/> Black, black <input type="checkbox"/> Black, white
---	---

Cutting Section

Cut out Ø75 mm



ACU 232002

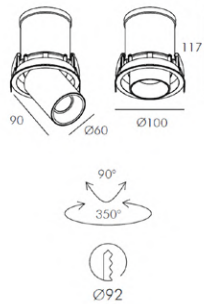

Wattage	Beam Angle
---------	------------

12W	15° 35°
-----	---------

Color Temperature	Lumen Output
-------------------	--------------

3000k	800 Lm
-------	--------

Installation	Rated Life Hours
--------------	------------------

Recessed	30,000 - 50,000H
----------	------------------

CRI	Material
-----	----------

≥90	Die Casting Aluminium
-----	-----------------------

Input Voltage	Colors
---------------	--------

220V AC (Via the Attached Remote Driver)	<input checked="" type="checkbox"/> Black, black <input type="checkbox"/> Black, white
---	---

Cutting Section

Cut out Ø92 mm



Ray Series

Adjustable with Square Frame

ACU 232003

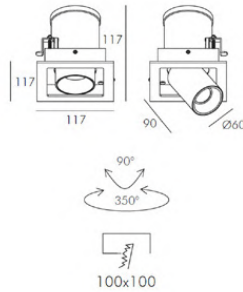

Wattage	Beam Angle
---------	------------

1x12W	15° 35°
-------	---------

Color Temperature	Lumen Output
-------------------	--------------

3000k	800 Lm
-------	--------

Installation	Rated Life Hours
--------------	------------------

Recessed	30,000 - 50,000H
----------	------------------

CRI	Colors
-----	--------

≥90	<input checked="" type="checkbox"/> Black <input type="checkbox"/> White
-----	--

Input Voltage	Material
---------------	----------

220V AC (Via the Attached Remote Driver)	Die Casting Aluminium
---	-----------------------

Cutting Section

Cut out
100 × 100 mm



ACU 232004

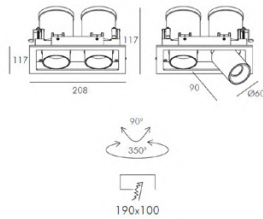

Wattage	Beam Angle
---------	------------

2x12W	15° 35°
-------	---------

Color Temperature	Lumen Output
-------------------	--------------

3000k	1540 Lm
-------	---------

Installation	Rated Life Hours
--------------	------------------

Recessed	30,000 - 50,000H
----------	------------------

CRI	Material
-----	----------

≥90	Die Casting Aluminium
-----	-----------------------

Input Voltage	Material
---------------	----------

220V AC (Via the Attached Remote Driver)	<input checked="" type="checkbox"/> Black, black <input type="checkbox"/> Black, white
---	---

Cutting Section

Cut out
190 × 100 mm



Ray Series

Adjustable with Round Frame

ACU 232005

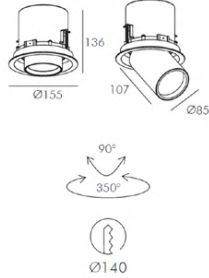

Wattage

25W

Beam Angle

15° 45°

Color Temperature

3000k

Lumen Output

1910 Lm

Installation

Recessed

Rated Life Hours

30,000 - 50,000H

CRI

≥90

Material

Die Casting Aluminium

Input Voltage

220V AC
(Via the Attached Remote Driver)

■ Black, black
□ Black, white

Cutting Section

Cut out Ø140 mm



ELARA COLLECTION

PS. Drivers are included with the lights for all operational functions.



Elara Series

Adjustable Spot Light

ACU 200701

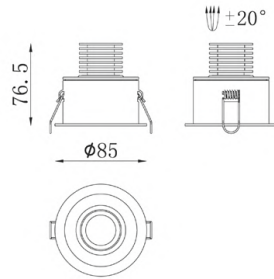

Wattage	Beam Angle
---------	------------

8W	24° 36°
----	---------

Color Temperature	Lumen Output
-------------------	--------------

3000k	664 Lm
-------	--------

Installation	Rated Life Hours
--------------	------------------

Recessed	30,000 - 50,000H
----------	------------------

CRI	Colors
-----	--------

≥90	■ Black □ White
-----	-----------------

Input Voltage	Material
---------------	----------

220V AC (Via the Attached Remote Driver)	Die Casting Aluminium
---	-----------------------

Cutting Section

Cut out Ø76 mm



SPARK COLLECTION

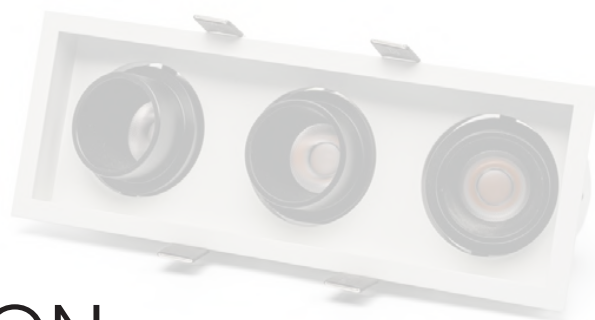

PS. Drivers are included with the lights for all operational functions.

Spark Series

Adjustable with Round Frame

ACU 231001

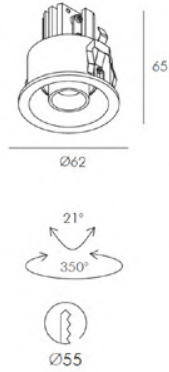

Wattage	Beam Angle
1x7W	20° 30°
Color Temperature	Lumen Output
3000k	358 Lm
Installation	Rated Life Hours
Recessed	30,000 - 50,000H
CRI	Colors
≥90	■ Black □ White
Input Voltage	Material
220V AC (Via the Attached Remote Driver)	Die Casting Aluminium
Cutting Section	
Cut out Ø55 mm	



Spark Series

Adjustable with Trimless Frame

ACU 231002

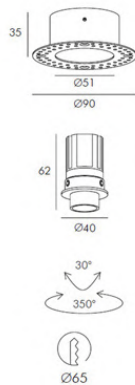

Wattage	Beam Angle
1x7W	20° 30°
Color Temperature	Lumen Output
3000k	800 Lm
Installation	Rated Life Hours
Trim-Less Recessed	30,000 - 50,000H
CRI	Colors
≥90	■ Black □ White
Input Voltage	Material
220V AC (Via the Attached Remote Driver)	Die Casting Aluminium
Cutting Section	
Cut out Ø65 mm	



Spark Series

Adjustable with Trimless Frame

ACU 231003

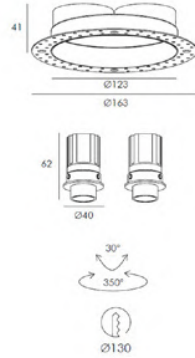

Wattage	Beam Angle
---------	------------

2x7W	20° 30°
------	---------

Color Temperature	Lumen Output
-------------------	--------------

3000k	744 Lm
-------	--------

Installation	Rated Life Hours
--------------	------------------

Trim-Less Recessed	30,000 - 50,000H
--------------------	------------------

CRI	Colors
-----	--------

≥90	■ Black □ White
-----	-----------------

Input Voltage	Material
---------------	----------

220V AC (Via the Attached Remote Driver)	Die Casting Aluminium
---	-----------------------

Cutting Section

Cut out Ø130 mm



Spark Series

Adjustable with Square Frame

ACU 231004

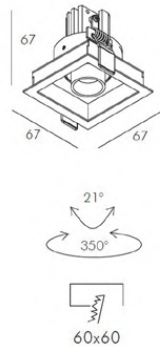

Wattage	Beam Angle
---------	------------

1x7W	20° 30°
------	---------

Color Temperature	Lumen Output
-------------------	--------------

3000k	800 Lm
-------	--------

Installation	Rated Life Hours
--------------	------------------

Trim-Less Recessed	30,000 - 50,000H
--------------------	------------------

CRI	Colors
-----	--------

≥90	■ Black □ White
-----	-----------------

Input Voltage	Material
---------------	----------

220V AC (Via the Attached Remote Driver)	Die Casting Aluminium
---	-----------------------

Cutting Section

Cut out 60 × 60 mm



Spark Series

Adjustable with Rectangular Frame

ACU 231005

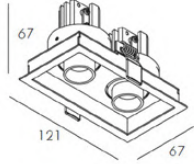

Wattage

2x7W

Beam Angle

20° 30°

Color Temperature

3000k

Lumen Output

803 Lm

Installation

Recessed

Rated Life Hours

30,000 - 50,000H

CRI

≥90

Material

Die Casting Aluminium

Input Voltage

220V AC
(Via the Attached Remote Driver)

Colors

■ Black, black
□ Black, white

Cutting Section

Cut out
L 115 × W 60 mm



Spark Series

Adjustable with Round Frame

ACU 231006

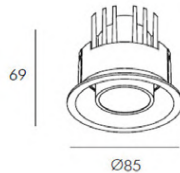

Wattage

1x10W

Beam Angle

20° 35°

Color Temperature

3000k

Lumen Output

612 Lm

Installation

Trim-Less Recessed

Rated Life Hours

30,000 - 50,000H

CRI

≥90

Colors

■ Black □ White

Input Voltage

220V AC
(Via the Attached Remote Driver)

Material

Die Casting Aluminium

Cutting Section

Cut out
Ø75 mm



Spark Series

Adjustable with Stadium Frame

ACU 231007

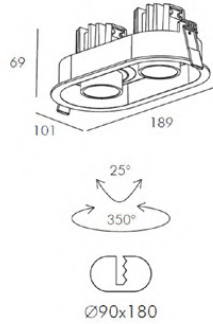

Wattage	Beam Angle
---------	------------

2x10W	20° 35°
-------	---------

Color Temperature	Lumen Output
-------------------	--------------

3000k	1143 Lm
-------	---------

Installation	Rated Life Hours
--------------	------------------

Recessed	30,000 - 50,000H
----------	------------------

CRI	Colors
-----	--------

≥90	<input checked="" type="checkbox"/> Black <input type="checkbox"/> White
-----	--

Input Voltage	Material
---------------	----------

220V AC (Via the Attached Remote Driver)	Die Casting Aluminium
---	-----------------------

Cutting Section

Cut out
Ø90 × L 180 mm



Spark Series

Adjustable with Square Frame

ACU 231008

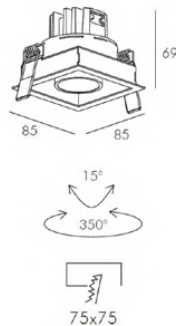

Wattage	Beam Angle
---------	------------

1x10W	20° 35°
-------	---------

Color Temperature	Lumen Output
-------------------	--------------

3000k	612 Lm
-------	--------

Installation	Rated Life Hours
--------------	------------------

Recessed	30,000 - 50,000H
----------	------------------

CRI	Material
-----	----------

≥90	Die Casting Aluminium
-----	-----------------------

Input Voltage

220V AC (Via the Attached Remote Driver)	<input checked="" type="checkbox"/> Black, black <input type="checkbox"/> Black, white
---	---

Cutting Section

Cut out
75 × 75 mm



Spark Series

Adjustable with Rectangular Frame

ACU 231009

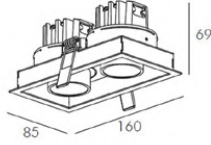

Wattage

2x10W

Beam Angle

20° 35°

Color Temperature

3000k

Lumen Output

1143 Lm

Installation

Recessed

Rated Life Hours

30,000 - 50,000H

CRI

≥90

Material

Die Casting Aluminium

Input Voltage

220V AC
(Via the Attached Remote Driver)

Colors

■ Black, black
□ Black, white

Cutting Section

Cut out
150 × 75 mm



Spark Series

Adjustable with Square Frame

ACU 231010

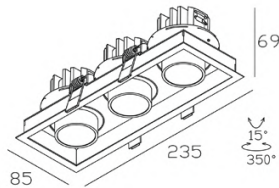

Wattage

3x10W

Beam Angle

20° 35°

Color Temperature

3000k

Lumen Output

1747 Lm

Installation

Recessed

Rated Life Hours

30,000 - 50,000H

CRI

≥90

Colors

■ Black □ White

Input Voltage

220V AC
(Via the Attached Remote Driver)

Material

Die Casting Aluminium

Cutting Section

Cut out
225 × 75mm



STEP COLLECTION



PS. Drivers are included with the lights for all operational functions.

Step Series

ACU 237003

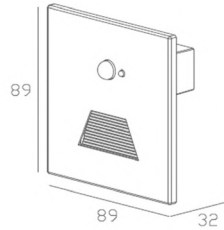

Wattage	Beam Angle
---------	------------

3W	110°
----	------

Color Temperature	Lumen Output
-------------------	--------------

3000k	Decorative Lumen Effect
-------	-------------------------

Installation	Rated Life Hours
--------------	------------------

Recessed	30,000 - 50,000H
----------	------------------

CRI	Colors
-----	--------

≥90	■ Black □ White
-----	-----------------

Input Voltage	Material
---------------	----------

220V AC (Built In Driver)	Iron + Aluminum + PC
------------------------------	----------------------

Cutting Section

Cut out 86mm





AURIGA

IP20 LED Strip Light

Indoor strip lighting offers a sleek, modern solution for indirect illumination. It is easy to install, energy-efficient, and designed to enhance any interior space with subtle, continuous lighting.

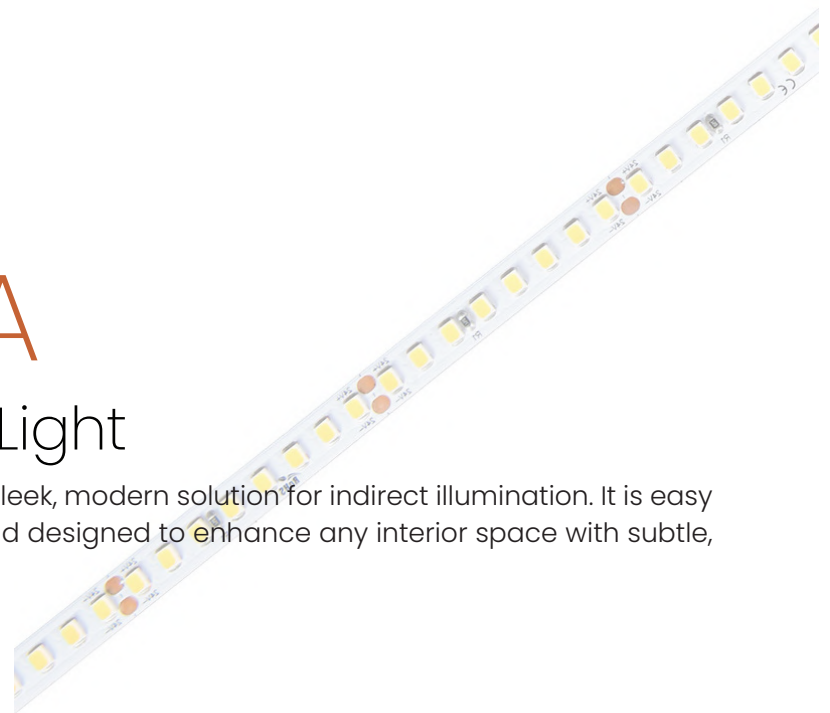



Auriga

LED SMD Strip Light

ACU ST 17041

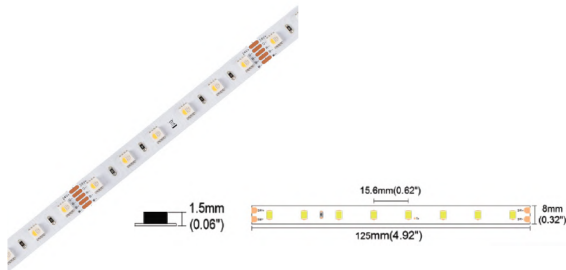

Wattage	Beam Angle
19.2 W/m	120°
Color Temperature	Lumen Output
RGBW3000	700 Lm
Installation	Rated Life Hours
Strip Light Accessories Profile & Clips	30,000 - 50,000H
CRI	Colors
≥90	<input type="checkbox"/> Transparent
Input Voltage	Material
24V DC	Strip Light
Dimension	Cutting Section
W 12mm x H 2.1mm, L-5000mm	100mm / 6 Leds



ACU ST 17047

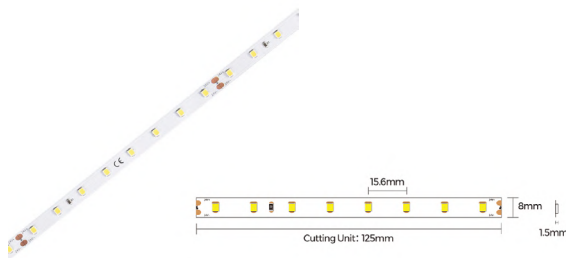

Wattage	Beam Angle
4.8 W/m	120°
Color Temperature	Lumen Output
3000k	540 Lm
Installation	Rated Life Hours
Strip Light Accessories Profile & Clips	30,000 - 50,000H
CRI	Colors
≥90	<input type="checkbox"/> Transparent
Input Voltage	Material
24V DC	Strip Light
Dimension	Cutting Section
W 8mm x H 1.5mm, L-5000mm	125mm / 8 Leds



Auriga

LED SMD Strip Light

ACU ST 17048

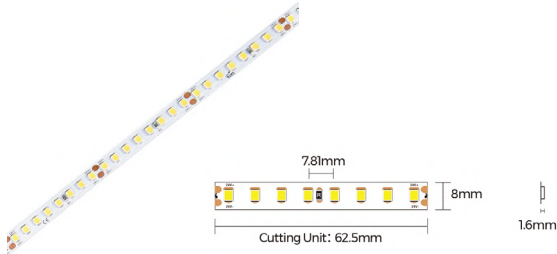

Wattage	Beam Angle
9.6 W/m	120°
Color Temperature	Lumen Output
3000K	1090 Lm/m
Installation	Rated Life Hours
Strip Light Accessories Profile & Clips	30,000 - 50,000H
CRI	Colors
≥90	<input type="checkbox"/> Transparent
Input Voltage	Material
24V DC	Strip Light
Dimension	Cutting Section
W 8mm x H 1.6mm, L-5000mm	62.5mm / 8 Leds



ACU ST 17049C

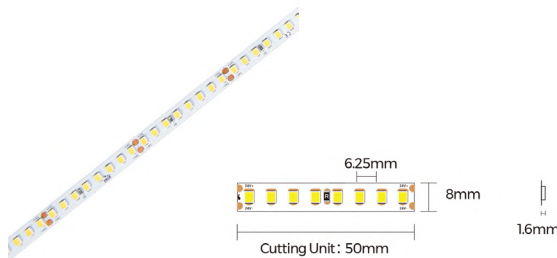

Wattage	Beam Angle
14.4 W/m	120°
Color Temperature	Lumen Output
3000K	1585 Lm/m
Installation	Rated Life Hours
Strip Light Accessories Profile & Clips	30,000 - 50,000H
CRI	Colors
≥90	<input type="checkbox"/> Transparent
Input Voltage	Material
24V DC	Strip Light
Dimension	Cutting Section
W 8mm x H 1.6mm, L-5000mm	50mm / 8 Leds



Auriga

LED COB Strip Light

ACU ST 202003

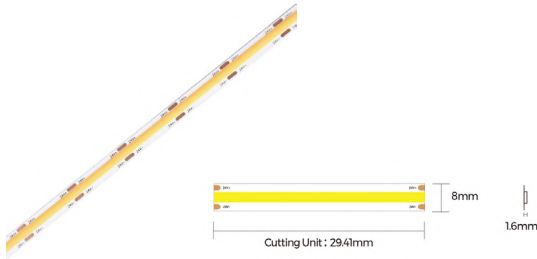

Wattage	Beam Angle
10 W/m	120°
Color Temperature	Lumen Output
RGBW3000	980 Lm/m
Installation	Rated Life Hours
Strip Light Accessories Profile & Clips	30,000 - 50,000H
CRI	Colors
≥90	<input type="checkbox"/> Transparent
Input Voltage	Material
24V DC	Strip Light
Dimension	Cutting Section
W 8mm x H 1.6mm, L-5000mm	29.41 mm



ACU ST 202004



Wattage	Beam Angle
5 W/m	120°
Color Temperature	Lumen Output
3000k	450 Lm/m
Installation	Rated Life Hours
Strip Light Accessories Profile & Clips	30,000 - 50,000H
CRI	Colors
≥90	<input type="checkbox"/> Transparent
Input Voltage	Material
24V DC	Strip Light
Dimension	Cutting Section
W 8mm x H 1.6mm, L-5000mm	29.41 mm



AURIGA

IP67 LED Strip Light

Outdoor strip lighting offers a sleek, modern solution for indirect illumination. It is easy to install, energy-efficient, and designed to enhance any exterior space with subtle, continuous lighting.





Auriga

LED SMD Strip Light

ACU ST 17058

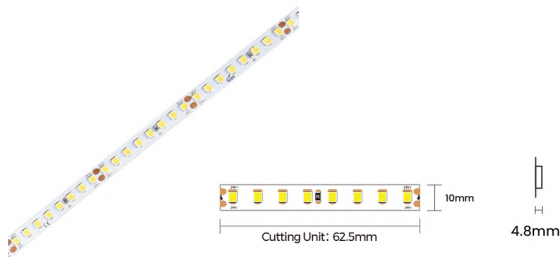

Wattage	Beam Angle
9.6 W/m	120°
Color Temperature	Lumen Output
3000k	960 Lm/m
Installation	Rated Life Hours
Strip Light Accessories Profile & Clips	30,000 - 50,000H
CRI	Colors
≥90	<input type="checkbox"/> Transparent
Input Voltage	Material
24V DC	Strip Light
Dimension	Cutting Section
W 10mm x H 4.8mm, L-5000mm	62.5mm / 8 Leds



ACU ST 17059C

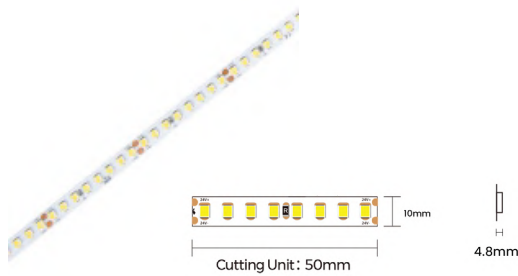

Wattage	Beam Angle
14.4 W/m	120°
Color Temperature	Lumen Output
3000k	1395 Lm/m
Installation	Rated Life Hours
Strip Light Accessories Profile & Clips	30,000 - 50,000H
CRI	Colors
≥90	<input type="checkbox"/> Transparent
Input Voltage	Material
24V DC	Strip Light
Dimension	Cutting Section
W 8mm x H 1.6mm, L-5000mm	50mm / 8 Leds



Auriga

LED SMD Strip Light

ACU ST 17059

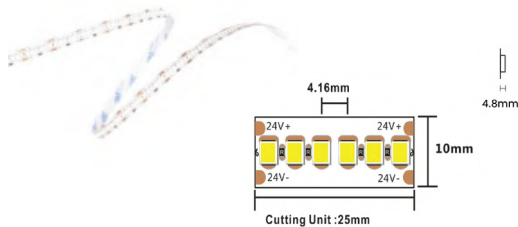

Wattage	Beam Angle
19 W/m	120°
Color Temperature	Lumen Output
3000k	1445 Lm/m
Installation	Rated Life Hours
Strip Light Accessories Profile & Clips	30,000 - 50,000H
CRI	Colors
≥90	<input type="checkbox"/> Transparent
Input Voltage	Material
24V DC	Strip Light
Dimention	Cutting Section
W 10mm x H 4.8mm, L-5000mm	25mm / 25 Leds



ACU ST 202101

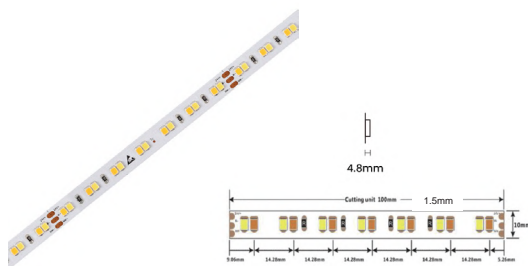

Wattage	Beam Angle
19.2 W/m	120°
Color Temperature	Lumen Output
Tunable 2700K-6000K	1505 Lm/m
Installation	Rated Life Hours
Strip Light Accessories Profile & Clips	30,000 - 50,000H
CRI	Colors
≥90	<input type="checkbox"/> Transparent
Input Voltage	Material
24V DC	Strip Light
Dimention	Cutting Section
W 10mm x H 1.5mm, L-5000mm	100mm / 14 Leds



Auriga

LED SMD Strip Light

ACU ST 202102

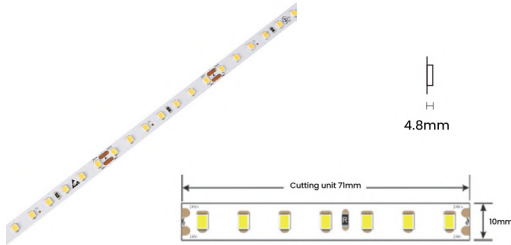

Wattage	Beam Angle
10.1 W/m	120°
Color Temperature	Lumen Output
1900K Amber	830 Lm/m
2300K Amber	705 Lm/m
6000K	906 Lm/m
Installation	Rated Life Hours
Strip Light Accessories Profile & Clips	30,000 - 50,000H
CRI	Colors
≥90	<input type="checkbox"/> Transparent
Input Voltage	Material
24V DC	Strip Light
Dimension	Cutting Section
W 10mm x H 4.8mm, L-5000mm	71.43mm / 7 Leds



Auriga

LED COB Strip Light

ACU ST 202001



Wattage	Beam Angle
10 W/m	120°
Color Temperature	Lumen Output
3000k	790 Lm/m
Installation	Rated Life Hours
Strip Light Accessories Profile & Clips	30,000 - 50,000H
CRI	Colors
≥90	<input type="checkbox"/> Transparent
Input Voltage	Material
24V DC	Strip Light
Dimension	Cutting Section
W 10mm x H 4.8mm, L-5000mm	29.41 mm



ACU ST 202002

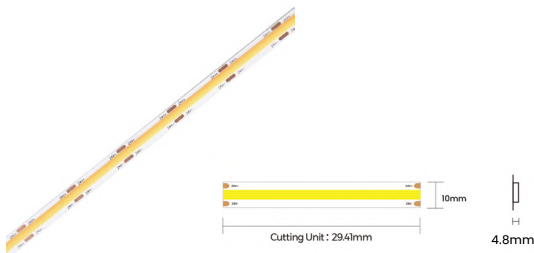

Wattage	Beam Angle
5 W/m	120°
Color Temperature	Lumen Output
3000k	410 Lm/m
Installation	Rated Life Hours
Strip Light Accessories Profile & Clips	30,000 - 50,000H
CRI	Colors
≥90	<input type="checkbox"/> Transparent
Input Voltage	Material
24V DC	Strip Light
Dimension	Cutting Section
W 10mm x H 4.8mm, L-5000mm	29.41mm





INDOOR LINEAR

Indoor linear lighting with an anti-glare diffuser ensures smooth, comfortable illumination while minimizing eye strain—perfect for modern, functional spaces.



INDOOR LINEAR
Honeycomb Diffuser

Surface Mounted | Suspended

Honeycomb Louver

ACU IL 240101SM

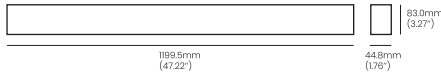

Wattage	Beam Angle
34W	60°x75°
Color Temperature	Lumen Output
3000k 4000k	2085 Lm 2195 Lm
Installation	Rated Life Hours
Surface Mounted	30,000 - 50,000H
CRI	Colors
≥90	■ Black
Input Voltage	Material
220V AC (Via the Attached Remote Driver)	Powder Coated Aluminum



ACU IL 240102SM

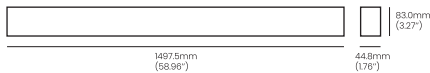

Wattage	Beam Angle
46W	60°x75°
Color Temperature	Lumen Output
3000k 4000k	2820 Lm 2965 Lm
Installation	Rated Life Hours
Surface Mounted	30,000 - 50,000H
CRI	Colors
≥90	■ Black
Input Voltage	Material
220V AC (Via the Attached Remote Driver)	Powder Coated Aluminum





Surface Mounted | Suspended

Honeycomb Louver

ACU IL 240103SM

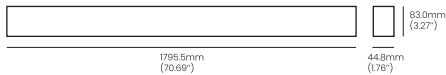

Wattage	Beam Angle
---------	------------

51W	60°x75°
-----	---------

Color Temperature	Lumen Output
-------------------	--------------

3000k	3125Lm
4000k	3290 Lm

Installation	Rated Life Hours
--------------	------------------

Surface Mounted	30,000 - 50,000H
-----------------	------------------

CRI	Colors
-----	--------

≥90	■ Black
-----	---------

Input Voltage	Material
---------------	----------

220V AC (Via the Attached Remote Driver)	Powder Coated Aluminum
---	------------------------

51W



ACU IL 240104SM



Wattage	Beam Angle
---------	------------

68W	60°x75°
-----	---------

Color Temperature	Lumen Output
-------------------	--------------

3000k	4165 Lm
4000k	4385 Lm

Installation	Rated Life Hours
--------------	------------------

Surface Mounted	30,000 - 50,000H
-----------------	------------------

CRI	Colors
-----	--------

≥90	■ Black
-----	---------

Input Voltage	Material
---------------	----------

220V AC (Via the Attached Remote Driver)	Powder Coated Aluminum
---	------------------------





INDOOR LINEAR
Louver Diffuser



Surface Mounted | Suspended

Louver

ACU IL 240201SM

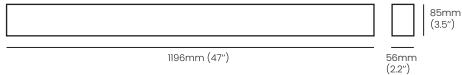
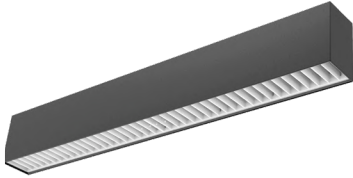

Wattage	Beam Angle
---------	------------

34W	72°
-----	-----

Color Temperature	Lumen Output
-------------------	--------------

3000k	1760 Lm
4000k	1890 Lm

Installation	Rated Life Hours
--------------	------------------

Surface Mounted	30,000 - 50,000H
-----------------	------------------

CRI	Colors
-----	--------

≥90	■ Black
-----	---------

Input Voltage	Material
---------------	----------

220V AC (Via the Attached Remote Driver)	Powder Coated Aluminum
---	------------------------



ACU IL 240202SM

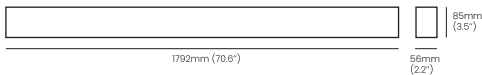
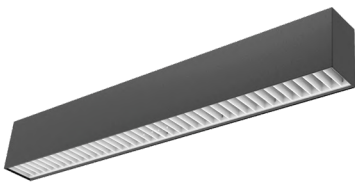

Wattage	Beam Angle
---------	------------

51W	72°
-----	-----

Color Temperature	Lumen Output
-------------------	--------------

3000k	2690 Lm
4000k	2830 Lm

Installation	Rated Life Hours
--------------	------------------

Surface Mounted	30,000 - 50,000H
-----------------	------------------

CRI	Colors
-----	--------

≥90	■ Black
-----	---------

Input Voltage	Material
---------------	----------

220V AC (Via the Attached Remote Driver)	Powder Coated Aluminum
---	------------------------



Surface Mounted | Suspended

Louver

ACU IL 240203SM

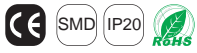
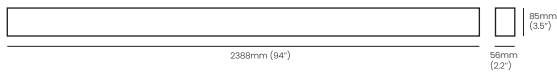
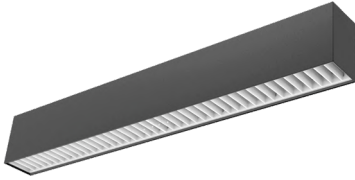

Wattage	Beam Angle
---------	------------

68W	72°
-----	-----

Color Temperature	Lumen Output
-------------------	--------------

3000k	3550 Lm
4000k	3770 Lm

Installation	Rated Life Hours
--------------	------------------

Surface Mounted	30,000 - 50,000H
-----------------	------------------

CRI	Colors
-----	--------

≥90	■ Black
-----	---------

Input Voltage	Material
---------------	----------

220V AC (Via the Attached Remote Driver)	Powder Coated Aluminum
---	---------------------------





INDOOR LINEAR
Prismatic Diffuser



Surface Mounted | Suspended

Prismatic Diffuser

ACU IL 240301SM

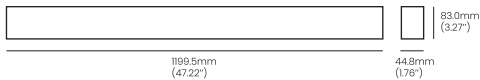
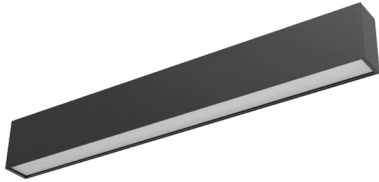

Wattage	Beam Angle
---------	------------

28W	65°x70°
-----	---------

Color Temperature	Lumen Output
-------------------	--------------

3000k	2745 Lm
4000k	2890 Lm

Installation	Rated Life Hours
--------------	------------------

Surface Mounted	30,000 - 50,000H
-----------------	------------------

CRI	Colors
-----	--------

≥90	■ Black
-----	---------

Input Voltage	Material
---------------	----------

220V AC (Via the Attached Remote Driver)	Powder Coated Aluminum
---	------------------------



ACU IL 240302SM

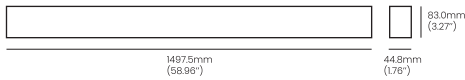
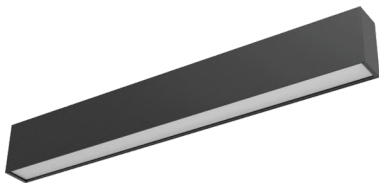

Wattage	Beam Angle
---------	------------

34W	65°x70°
-----	---------

Color Temperature	Lumen Output
-------------------	--------------

3000k	3335 Lm
4000k	3510 Lm

Installation	Rated Life Hours
--------------	------------------

Surface Mounted	30,000 - 50,000H
-----------------	------------------

CRI	Colors
-----	--------

≥90	■ Black
-----	---------

Input Voltage	Material
---------------	----------

220V AC (Via the Attached Remote Driver)	Powder Coated Aluminum
---	------------------------



Surface Mounted | Suspended

Prismatic Diffuser

ACU IL 240303SM

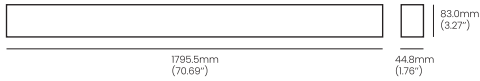
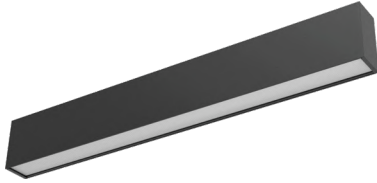

Wattage

40W

Beam Angle

65°x70°

Color Temperature

3000k
4000k

Lumen Output

3920 Lm
4130 Lm

Installation

Surface Mounted

Rated Life Hours

30,000 - 50,000H

CRI

≥90

Colors

■ Black

Input Voltage

220V AC
(Via the Attached Remote Driver)

Material

Powder Coated
Aluminum



INDOOR LINEAR
Recessed





Recessed

Indoor Linear

ACU IL 240401R

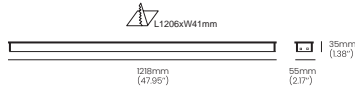

Wattage	Beam Angle
19W	110°
Color Temperature	Lumen Output
3000k 4000k	1900 Lm 2020 Lm
Installation	Rated Life Hours
Recessed	30,000 - 50,000H
CRI	Colors
≥90	■ Black
Input Voltage	Material
220V AC (Via the Attached Remote Driver)	Powder Coated Aluminum



ACU IL 240402R

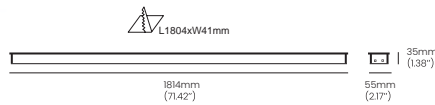

Wattage	Beam Angle
27W	65°x70°
Color Temperature	Lumen Output
3000k 4000k	2700 Lm 2870 Lm
Installation	Rated Life Hours
Recessed	30,000 - 50,000H
CRI	Colors
≥90	■ Black
Input Voltage	Material
220V AC (Via the Attached Remote Driver)	Powder Coated Aluminum



Recessed

Indoor Linear

ACU IL 240403R

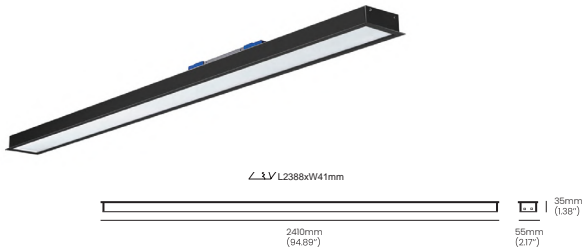

Wattage	Beam Angle
38W	110°
Color Temperature	Lumen Output
3000k 4000k	3800 Lm 4040 Lm
Installation	Rated Life Hours
Recessed	30,000 - 50,000H
CRI	Colors
≥90	■ Black
Input Voltage	Material
220V AC (Via the Attached Remote Driver)	Powder Coated Aluminum



ACU IL 240404R

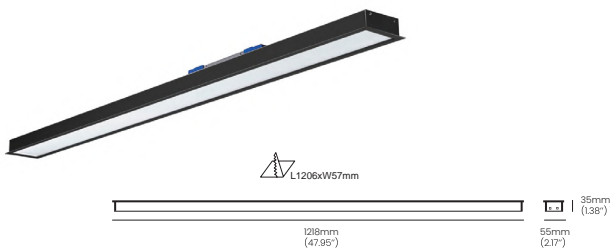

Wattage	Beam Angle
27W	110°
Color Temperature	Lumen Output
3000k 4000k	2800 Lm 2980 Lm
Installation	Rated Life Hours
Recessed	30,000 - 50,000H
CRI	Colors
≥90	■ Black
Input Voltage	Material
220V AC (Via the Attached Remote Driver)	Powder Coated Aluminum



Recessed

Indoor Linear

ACU IL 240405R

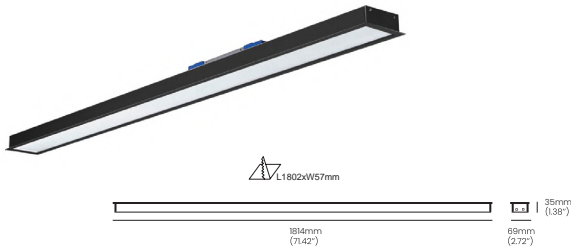

Wattage	Beam Angle
38W	110°
Color Temperature	Lumen Output
3000k 4000k	3950 Lm 4200 Lm
Installation	Rated Life Hours
Recessed	30,000 - 50,000H
CRI	Colors
≥90	■ Black
Input Voltage	Material
220V AC (Via the Attached Remote Driver)	Powder Coated Aluminum



ACU IL 240406R

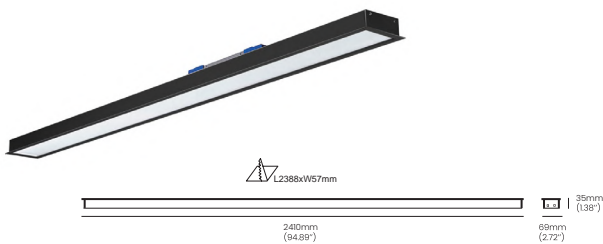

Wattage	Beam Angle
53W	110°
Color Temperature	Lumen Output
3000k 4000k	5510 Lm 5860 Lm
Installation	Rated Life Hours
Recessed	30,000 - 50,000H
CRI	Colors
≥90	■ Black
Input Voltage	Material
220V AC (Via the Attached Remote Driver)	Powder Coated Aluminum



Recessed

Indoor Linear

ACU IL 240407R

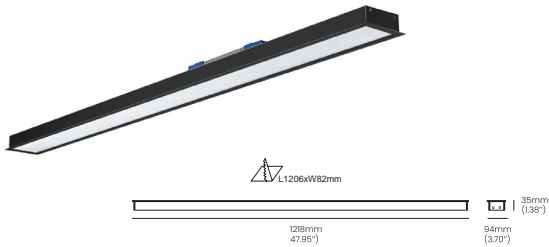

Wattage	Beam Angle
38W	110°
Color Temperature	Lumen Output
3000k 4000k	3950 Lm 4200 Lm
Installation	Rated Life Hours
Recessed	30,000 - 50,000H
CRI	Colors
≥90	■ Black
Input Voltage	Material
220V AC (Via the Attached Remote Driver)	Powder Coated Aluminum



ACU IL 240408R

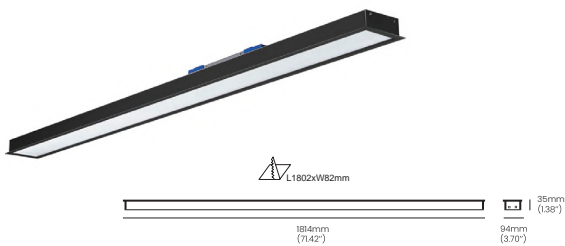

Wattage	Beam Angle
60W	110°
Color Temperature	Lumen Output
3000k 4000k	6230 Lm 6630 Lm
Installation	Rated Life Hours
Recessed	30,000 - 50,000H
CRI	Colors
≥90	■ Black
Input Voltage	Material
220V AC (Via the Attached Remote Driver)	Powder Coated Aluminum



Recessed

Indoor Linear

ACU IL 240409R

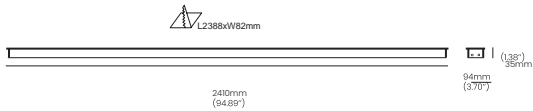

Wattage	Beam Angle
---------	------------

38W	110°
-----	------

Color Temperature	Lumen Output
-------------------	--------------

3000k	7790 Lm
4000k	8290 Lm

Installation	Rated Life Hours
--------------	------------------

Recessed	30,000 - 50,000H
----------	------------------

CRI	Colors
-----	--------

≥90	■ Black
-----	---------

Input Voltage	Material
---------------	----------

220V AC (Via the Attached Remote Driver)	Powder Coated Aluminum
---	---------------------------





METEOR MAGNETIC

24V DC

Grazer Light

Meteor Magnetic

ACU MM 243010

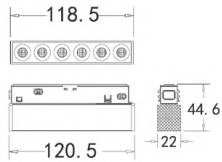

Wattage	Beam Angle
6W	24° 38°
Color Temperature	Lumen Output
3000k	524 Lm
Installation	Rated Life Hours
Magnetic System	30,000 - 50,000H
CRI	Colors
≥90	■ Black □ White
Input Voltage	Material
24V DC	Aluminum + PC



ACU MM 243011

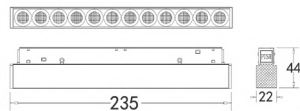
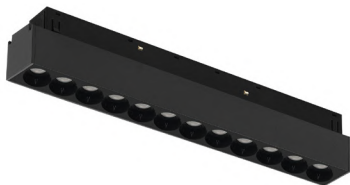

Wattage	Beam Angle
10W	24° 38°
Color Temperature	Lumen Output
3000k	1000 Lm
Installation	Rated Life Hours
Magnetic System	30,000 - 50,000H
CRI	Colors
≥90	■ Black □ White
Input Voltage	Material
24V DC	Aluminum + PC





Grazer Light

Meteor Magnetic

ACU MM 243012

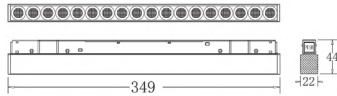

Wattage	Beam Angle
16W	24° 38°
Color Temperature	Lumen Output
3000k	1527 Lm
Installation	Rated Life Hours
Magnetic System	30,000 - 50,000H
CRI	Colors
≥90	■ Black □ White
Input Voltage	Material
24V DC	Aluminum + PC



ACU MM 243013

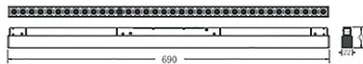

Wattage	Beam Angle
24W	24° 38°
Color Temperature	Lumen Output
3000k	2012 Lm
Installation	Rated Life Hours
Magnetic System	30,000 - 50,000H
CRI	Colors
≥90	■ Black □ White
Input Voltage	Material
24V DC	Aluminum + PC





Linear Light

Meteor Magnetic

ACU MM 243020

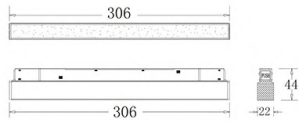

Wattage	Beam Angle
10W	110°
Color Temperature	Lumen Output
3000k	864 Lm
Installation	Rated Life Hours
Magnetic System	30,000 - 50,000H
CRI	Colors
≥90	■ Black □ White
Input Voltage	Material
24V DC	Aluminum + PC



ACU MM 243021

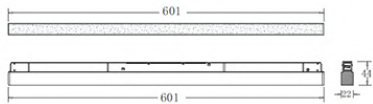

Wattage	Beam Angle
16W	110°
Color Temperature	Lumen Output
3000k	1768 Lm
Installation	Rated Life Hours
Magnetic System	30,000 - 50,000H
CRI	Colors
≥90	■ Black □ White
Input Voltage	Material
24V DC	Aluminum + PC



Wall Washer

Meteor Magnetic

ACU MM 243065

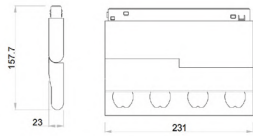

Wattage	Beam Angle
15W	33°
Color Temperature	Lumen Output
3000k	1000 Lm
Installation	Rated Life Hours
Magnetic System	30,000 - 50,000H
CRI	Colors
≥90	■ Black □ White
Input Voltage	Material
24V DC	Aluminum



Spot Light

Meteor Magnetic

ACU MM 243030

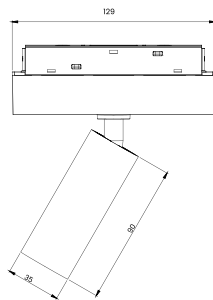

Wattage	Beam Angle
8W	38°
Color Temperature	Lumen Output
3000k	1768 Lm
Installation	Rated Life Hours
Magnetic System	30,000 - 50,000H
CRI	Colors
≥90	■ Black □ White
Input Voltage	Material
24V DC	Aluminum + PC





Spot Light

Meteor Magnetic

ACU MM 243031



Wattage	Beam Angle
2x8W	24° 40°
Color Temperature	Lumen Output
3000k	1329 Lm
Installation	Rated Life Hours
Magnetic System	30,000 - 50,000H
CRI	Colors
≥90	■ Black □ White
Input Voltage	Material
24V DC	Aluminum + PC



ACU MM 243032

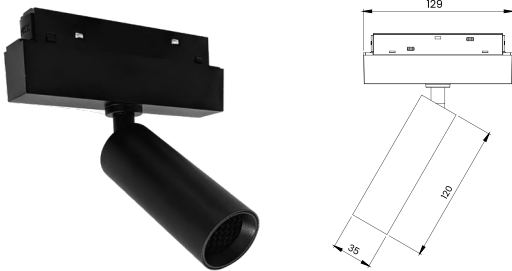

Wattage	Beam Angle
12W	15° 24° 38°
Color Temperature	Lumen Output
3000k	1396 Lm
Installation	Rated Life Hours
Magnetic System	30,000 - 50,000H
CRI	Colors
≥90	■ Black □ White
Input Voltage	Material
24V DC	Aluminum + PC





Zoomable Light

Meteor Magnetic

ACU MM 243034

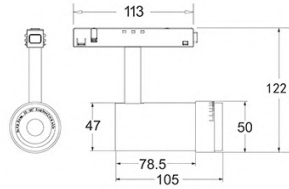

Wattage	Beam Angle
10W	10° to 60°
Color Temperature	Lumen Output
3000k	739 Lm
Installation	Rated Life Hours
Magnetic System	30,000 - 50,000H
CRI	Colors
≥90	■ Black □ White
Input Voltage	Material
24V DC	Aluminum + PC



ACU MM 243035

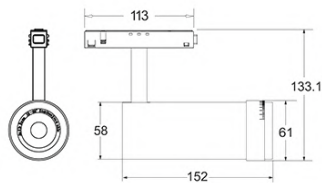

Wattage	Beam Angle
16W	10° to 60°
Color Temperature	Lumen Output
3000k	1484 Lm
Installation	Rated Life Hours
Magnetic System	30,000 - 50,000H
CRI	Colors
≥90	■ Black □ White
Input Voltage	Material
24V DC	Aluminum + PC



Wide Spot Light

Meteor Magnetic

ACU MM 243036

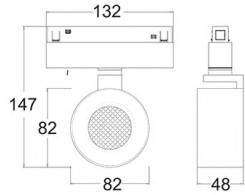

Wattage	Beam Angle
10W	10° 24° 36°
Color Temperature	Lumen Output
3000k	877 Lm
Installation	Rated Life Hours
Magnetic System	30,000 - 50,000H
CRI	Colors
≥90	■ Black □ White
Input Voltage	Material
24V DC	Aluminum + PC



Adjustable Grazer

ACU MM 243040

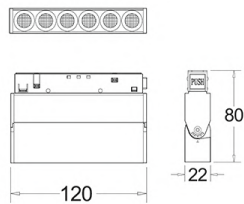

Wattage	Beam Angle
6W	24° 38°
Color Temperature	Lumen Output
3000k	469 Lm
Installation	Rated Life Hours
Magnetic System	30,000 - 50,000H
CRI	Colors
≥90	■ Black □ White
Input Voltage	Material
24V DC	Aluminum + PC





Adjustable Grazer

ACU MM 243041

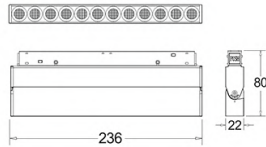

Wattage	Beam Angle
10W	24° 38°
Color Temperature	Lumen Output
3000k	1000 Lm
Installation	Rated Life Hours
Magnetic System	30,000 - 50,000H
CRI	Colors
≥90	■ Black □ White
Input Voltage	Material
24V DC	Aluminum + PC



ACU MM 243042

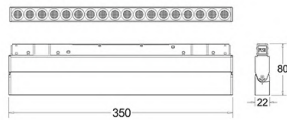

Wattage	Beam Angle
16W	24° 38°
Color Temperature	Lumen Output
3000k	1527 Lm
Installation	Rated Life Hours
Magnetic System	30,000 - 50,000H
CRI	Colors
≥90	■ Black □ White
Input Voltage	Material
24V DC	Aluminum + PC



Adjustable Grazer

ACU MM 243043

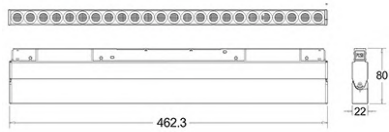

Wattage	Beam Angle
24W	24° 38°
Color Temperature	Lumen Output
3000k	2012 Lm
Installation	Rated Life Hours
Magnetic System	30,000 - 50,000H
CRI	Colors
≥90	■ Black □ White
Input Voltage	Material
24V DC	Aluminum + PC



Adjustable Linear

ACU MM 243050

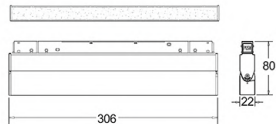

Wattage	Beam Angle
10W	110°
Color Temperature	Lumen Output
3000k	864 Lm
Installation	Rated Life Hours
Magnetic System	30,000 - 50,000H
CRI	Colors
≥90	■ Black □ White
Input Voltage	Material
24V DC	Aluminum + PC



Adjustable Grazer

ACU MM 243051



Wattage	Beam Angle
16W	110°
Color Temperature	Lumen Output
3000k	1786 Lm
Installation	Rated Life Hours
Magnetic System	30,000 - 50,000H
CRI	Colors
≥90	■ Black □ White
Input Voltage	Material
24V DC	Aluminum + PC



Decorative Lights

ACU MM 243060

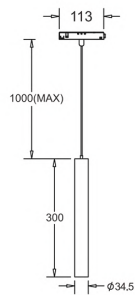

Wattage	Beam Angle
10W	24° 40°
Color Temperature	Lumen Output
3000k	891 Lm
Installation	Rated Life Hours
Magnetic System	30,000 - 50,000H
CRI	Colors
≥90	■ Black □ White
Input Voltage	Material
24V DC	Aluminum + PC





Decorative Lights

ACU MM 243061

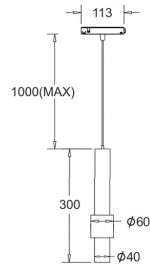

Wattage	Beam Angle
12W	24° 38°
Color Temperature	Lumen Output
3000k	576 Lm
Installation	Rated Life Hours
Magnetic System	30,000 - 50,000H
CRI	Colors
≥90	■ Black □ White
Input Voltage	Material
24V DC	Aluminum + PC



ACU MM 243062

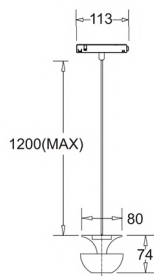

Wattage	Beam Angle
6W	15° 24° 38°
Color Temperature	Lumen Output
3000k	891 Lm
Installation	Rated Life Hours
Magnetic System	30,000 - 50,000H
CRI	Colors
≥90	■ Black □ White
Input Voltage	Material
24V DC	Aluminum + PC



Decorative Lights

ACU MM 243063

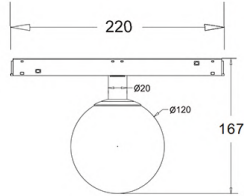

Wattage	Beam Angle
6W	235°
Color Temperature	Lumen Output
3000k	375 Lm
Installation	Rated Life Hours
Magnetic System	30,000 - 50,000H
CRI	Colors
≥90	■ Black □ White
Input Voltage	Material
24V DC	Aluminum + PC



ACU MM 243064

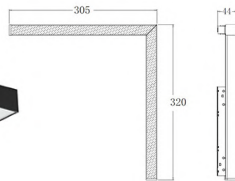

Wattage	Beam Angle
16W	110°
Color Temperature	Lumen Output
3000k	1063 Lm
Installation	Rated Life Hours
Magnetic System	30,000 - 50,000H
CRI	Colors
≥90	■ Black □ White
Input Voltage	Material
24V DC	Aluminum + PC



Magnetic Track & **Accessories**

Before Gypsum Ceiling

ACU MMT 001BGR

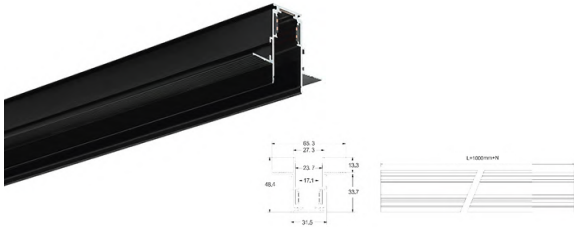

Installation

Magnetic System

Colors

■ Black □ White

Materials

Aluminum + Copper



ACU MMT 002BGR

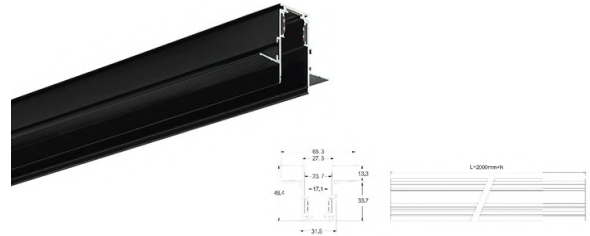

Installation

Magnetic System

Colors

■ Black □ White

Materials

Aluminum + Copper



ACU A/C MMT 001R



Materials

Aluminum + Copper

Colors

■ Black □ White

Installation

Recessed



ACU MMAC 0229BGR

Right Angle Connector

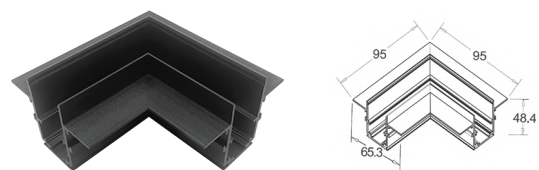

Materials

Aluminum

Colors

■ Black □ White

Installation

Magnetic System To Connect
Between Two Track Rails Horizontally



Before Gypsum Ceiling

ACU MMAC 0230BGR

Outer Angle Connector



Materials

Aluminum

Colors

■ Black □ White

Installation

Magnetic System To Connect
Between Two Track Rails
Horizontally and Vertically
- Outer Side
- Ceiling → Wall



ACU MMAC 0231BGR

Inner Angle Connector

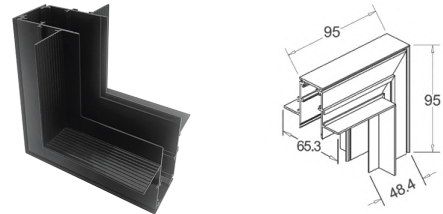

Materials

Aluminum

Colors

■ Black □ White

Installation

Magnetic System To Connect
Between Two Track Rails
Horizontally and Vertically
- Inner Side
- Ceiling → Wall
- Wall → Wall



ACU MMAC 0236BGR

T Connector

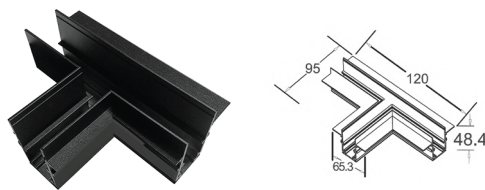

Materials

Aluminum

Colors

■ Black □ White

Installation

Magnetic System To Connect
Between Three Track Rails Horizontally



ACU MMAC 0237BGR

X Connector

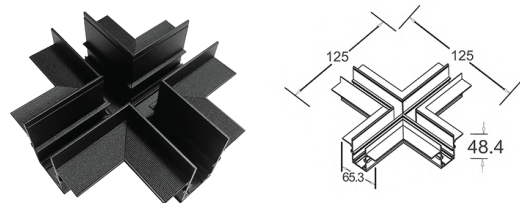

Materials

Aluminum

Colors

■ Black □ White

Installation

Magnetic System To Connect
Between Four Track Rails Horizontally



After Gypsum Ceiling

ACU MMT 001AGR

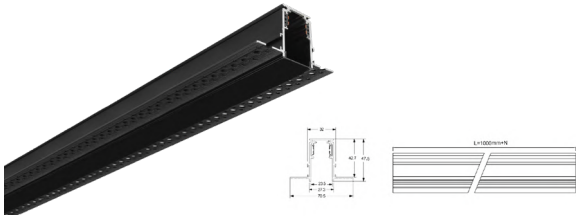

Installation

Magnetic System

Colors

■ Black □ White

Materials

Aluminum + Copper



ACU MMT 002AGR

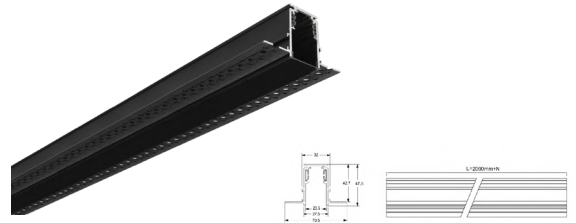

Installation

Magnetic System

Colors

■ Black □ White

Materials

Aluminum + Copper



ACU MMAC 0229AGR

Right Angle Connector

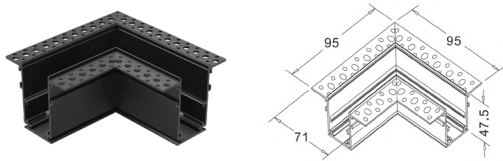

Installation

Magnetic System

Colors

■ Black □ White

Materials

Aluminum



ACU MMAC 0230AGR

Outer Angle Connector

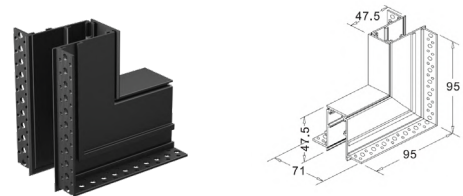

Installation

Magnetic System

Colors

■ Black □ White

Materials

Aluminum



After Gypsum Ceiling

ACU MMAC 0231AGR

Inner Angle Connector

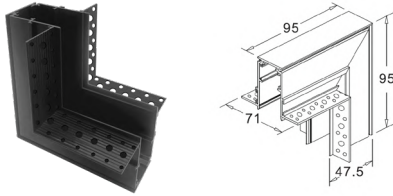

Installation

Magnetic System

Colors

■ Black □ White

Materials

Aluminum



ACU MMAC 0236AGR

T Connector

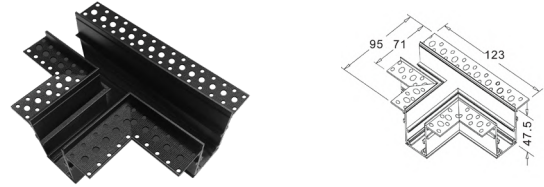

Installation

Magnetic System

Colors

■ Black □ White

Materials

Aluminum



ACU MMAC 0237AGR

X Connector

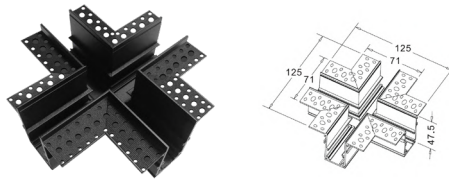

Installation

Magnetic System

Colors

■ Black □ White

Materials

Aluminum



Surface Mounted

ACU MMT 001SM

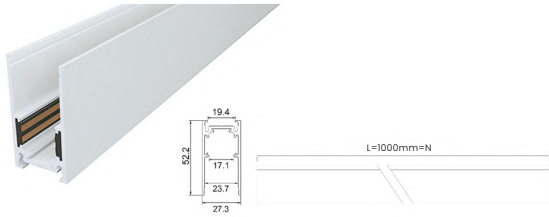

Installation

Magnetic System

Colors

■ Black □ White

Materials

Aluminum + Copper



ACU MMT 002SM

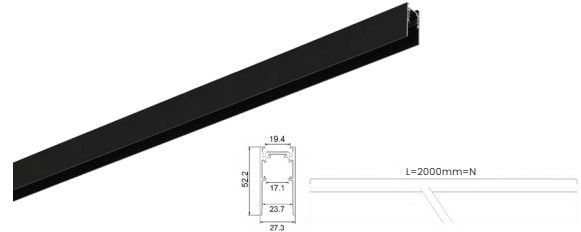

Installation

Magnetic System

Colors

■ Black □ White

Materials

Aluminum + Copper



ACU MMAC 0226

Right Angle Connector

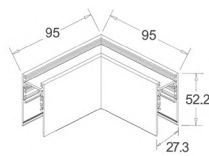

Installation

Mini Magnetic System

Colors

■ Black □ White

Materials

Aluminum + Copper



ACU MMAC 0227

Outer Angle Connector

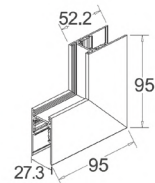

Installation

Mini Magnetic System

Colors

■ Black □ White

Materials

Aluminum + Copper



ACU MMAC 0228

Inner Angle Connector

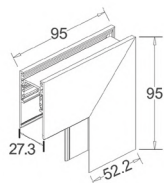

Installation

Mini Magnetic System

Colors

■ Black □ White

Materials

Aluminum + Copper



ACU MMAC 0252

T connector

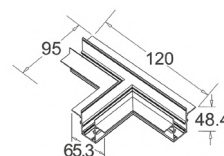

Installation

Mini Magnetic System

Colors

■ Black □ White

Materials

Aluminum + Copper



ACU MMAC 0253

X connector

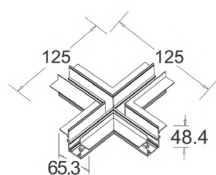

Installation

Mini Magnetic System

Colors

■ Black □ White

Materials

Aluminum + Copper



POWER

Accessories

ACU MMAC 0212

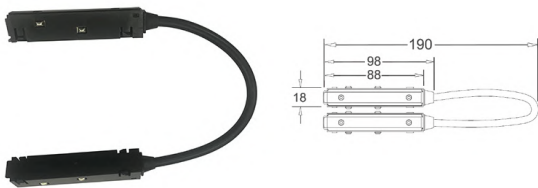

Installation

Magnetic System

Colors

□ White



ACU MMAC 0221

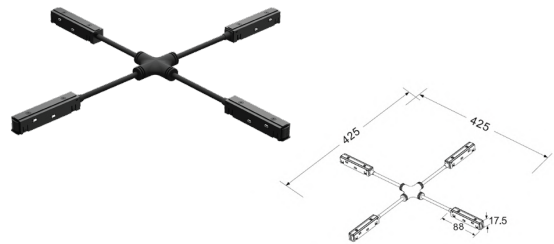

Installation

Magnetic System

4-side Power Connector



Power Accessories

ACU MMAC 0222



Installation

Magnetic System

Colors

■ Black □ White

Power Connector



ACU MMAC 0223

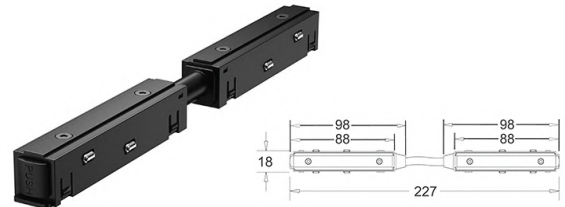

Installation

Magnetic System

Colors

■ Black □ White

Power Connector



ACU MMAC 0224

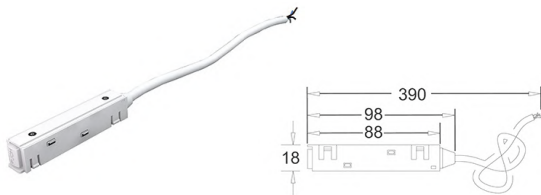

Installation

Magnetic System

Materials

Aluminum + Copper

Power Feeder



Track Light &
Rail Accessories
220V AC

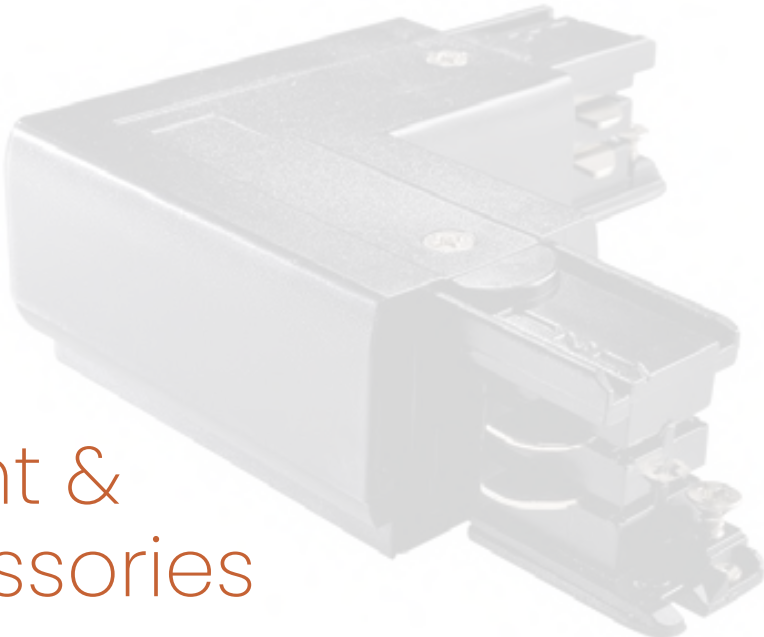

Mensa Track

Track Rail

ACU TR 0410R

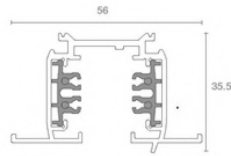

■ Black □ White

Installation	IP RATE
Recessed	20

ACU TR 0410S

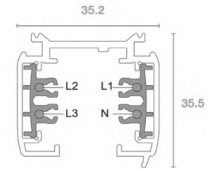

■ Black □ White

Installation	IP RATE
Surface Mounted	20



Mensa Track Accessories

Power Feeder

ACU PF 0431-L



■ Black □ White

Installation	IP RATE
Accessory with Track Rail	20

ACU PF 0431-R



■ Black □ White

Installation	IP RATE
Accessory with Track Rail	20

ACU TA 0432

End Cap



■ Black □ White

Installation	IP RATE
Accessory with Track Rail	20

ACU TA 0433

Fixed Straight Power Joiner (M & E)



■ Black □ White

Installation	IP RATE
Accessory with Track Rail	20

Mensa Track Accessories

Power Feeder

ACU PF 0434

Middle Power Feeder



■ Black □ White

Installation	IP RATE
Accessory with Track Rail	20

ACU TA 0434C

Cover for Middle Connector



■ Black □ White

Installation	IP RATE
Accessory with Track Rail	20

Mensa Track Accessories

Adjustable Connector

ACU TA 0435 Adj



■ Black □ White

Installation	IP RATE
Accessory with Track Rail	20

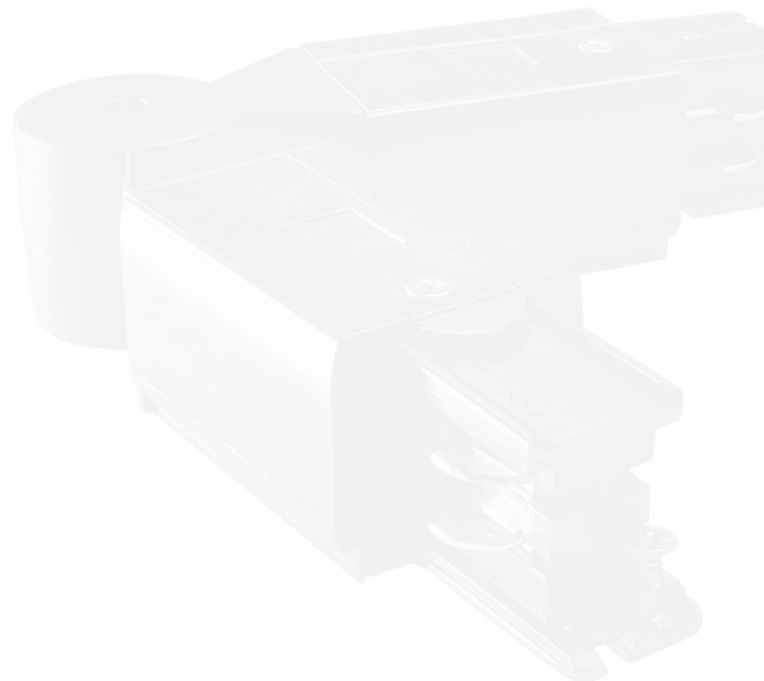

Mensa Track Accessories

L & R Connector Left Side

ACU TA 0435-L



■ Black □ White

Installation	IP RATE
Accessory with Track Rail	20

ACU TA 0435-R



■ Black □ White

Installation	IP RATE
Accessory with Track Rail	20

Mensa Track Accessories

Cover for L-Connector

ACU TA 0435C



■ Black □ White

Installation	IP RATE
Accessory with Track Rail	20

Mensa Track Accessories

Twisted T Connector L1 → L2

Twisted T Connector R1 → R2

ACU TA 0436-L



■ Black □ White

Installation	IP RATE
Accessory with Track Rail	20

ACU TA 0436-R



■ Black □ White

Installation	IP RATE
Accessory with Track Rail	20

Mensa Track Accessories

Cover for T-Connector

ACU TA 0436C



■ Black □ White

Installation	IP RATE
Accessory with Track Rail	20

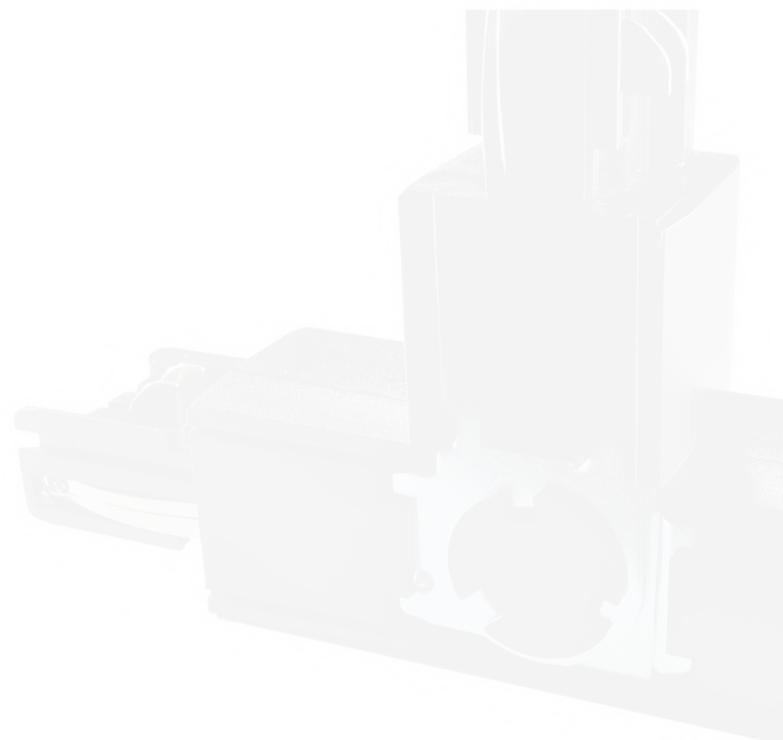

Mensa Track Accessories

ACU TA 0437

X Connector



■ Black □ White

Installation	IP RATE
Accessory with Track Rail	20

ACU TA 0437C

Cover for X-Connector

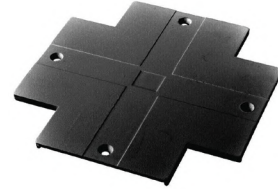

■ Black □ White

Installation	IP RATE
Accessory with Track Rail	20

Mensa Track Accessories

ACU TA 0438

Twisted L Connector (L & R)



■ Black □ White

Installation	IP RATE
Accessory with Track Rail	20

ACU TA 0439

Flexible Track Rail Connector



■ Black □ White

Installation	IP RATE
Accessory with Track Rail	20

Mensa Track Accessories

Coupler / Fixed Straight Joiner

ACU TA M0433

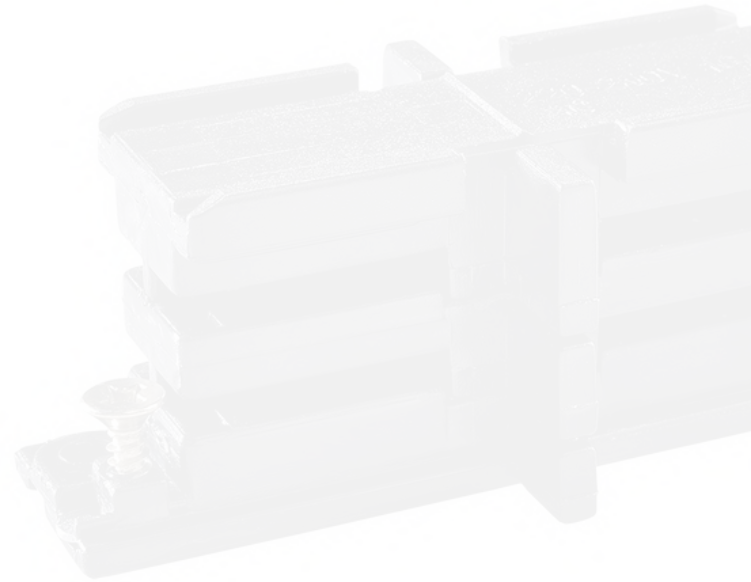

■ Black □ White

Installation	IP RATE
Accessory with Track Rail	20

Mensa Track – DALI

Track Rail

ACU TR 0610R



■ Black □ White

Installation	IP RATE
Recessed	20
DALI	

ACU TR 0610S



■ Black □ White

Installation	IP RATE
Surface Mounted	20
DALI	

Mensa Track Accessories – Dali

Power Feeder Left Side – DALI

ACU PF 0631-L



■ Black □ White

Installation	IP RATE
Accessorry with Track Rail	20
DALI	

ACU PF 0631-R



■ Black □ White

Installation	IP RATE
Accessorry with Track Rail	20
DALI	

ACU PF 0631C

Cover for Power Feeder – DALI



■ Black □ White

Installation	IP RATE
Accessorry with Track Rail	20
DALI	

ACU PF 0634

Middle Power Feeder – DALI



■ Black □ White

Installation	IP RATE
Accessorry with Track Rail	20
DALI	

Mensa Track Accessories – Dali

Coupler / Fixed Straight Power Joiner – DALI

ACU TA 0633

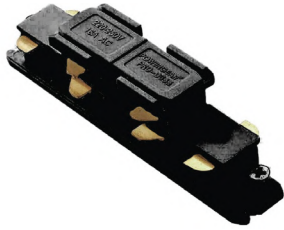

■ Black □ White

Installation	IP RATE
Accessory with Track Rail	20
DALI	

Mensa Track Accessories – Dali

L Connector Left & Right Side – DALI

ACU TA 0635-L



■ Black □ White

Installation	IP RATE
Accessory with Track Rail	20
DALI	

ACU TA 0635-R



■ Black □ White

Installation	IP RATE
Accessory with Track Rail	20
DALI	

Mensa Track Accessories – Dali

ACU TA 0637

X Connector – DALI

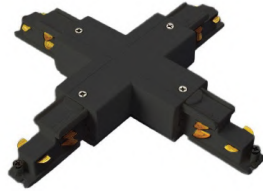

■ Black □ White

Installation	IP RATE
Accessory with Track Rail	20
DALI	

ACU TA 0638

Twisted L Connector (L & R) DALI



■ Black □ White

Installation	IP RATE
Accessory with Track Rail	20
DALI	

Mensa Track Accessories – Dali

Flexible Connector – DALI

ACU TA 0639



■ Black □ White

Installation	IP RATE
Accessory with Track Rail	20
DALI	

Suspension Accessories

ACU SA 04

Mounting Clamp Bracket



■ Black □ White

Installation	IP RATE
Suspension Accessory with Track Rail	20

ACU SA 0418

Suspension Connection Clamp



■ Black □ White

Installation	IP RATE
Suspension Accessory with Track Rail	20

Mensa Track Accessories

ACU SH 142

Suspension Hook



■ Black □ White

Installation	IP RATE
Suspension Accessory with Track Rail	20

ACU SR 0447

Ceiling Rod Suspension Kit

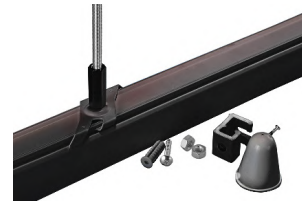

■ Black □ White

Installation	IP RATE
Suspension Accessory with Track Rail	20

Suspension Accessories

Suspension Kit (Wire)

ACU SW 0448

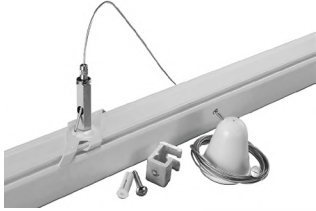

■ Black □ White

Installation	IP RATE
Suspension Accessory with Track Rail	20

Mono Track

Mono Track

ACU MT 100



■ Black □ White

Installation	IP RATE
Surface Mounted	20

ACU MT 150



■ Black □ White

Installation	IP RATE
Surface Mounted	20
DALI	

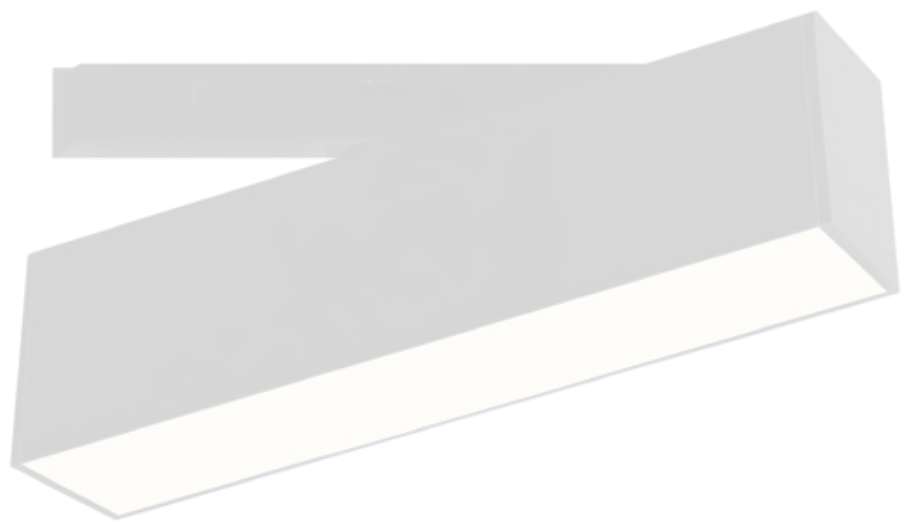

PAVO TRACK

Designed for use with 220V AC
track rail systems



Track Linear light

Rotatable Linear

ACU TL 244020

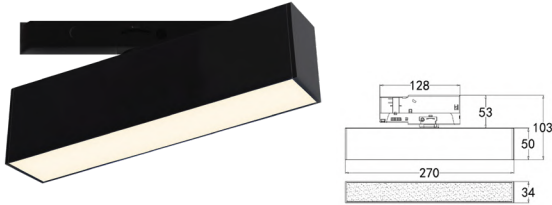

Wattage	Beam Angle
---------	------------

9W	110°
----	------

Color Temperature	Lumen Output
-------------------	--------------

3000k	515 Lm
-------	--------

Installation	Rated Life Hours
--------------	------------------

Track Mounted	30,000 - 50,000H
---------------	------------------

CRI	Colors
-----	--------

≥90	<input checked="" type="checkbox"/> Black <input type="checkbox"/> White
-----	--

Input Voltage	Material
---------------	----------

220V AC (with the Attached Built in Driver)	Podwer Coated Aluminum
--	------------------------



ACU TL 244021

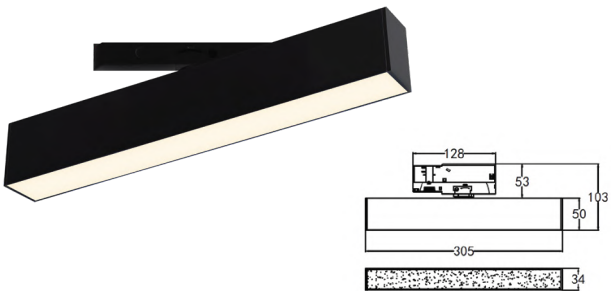

Wattage	Beam Angle
---------	------------

18W	110°
-----	------

Color Temperature	Lumen Output
-------------------	--------------

3000k	1018 Lm
-------	---------

Installation	Rated Life Hours
--------------	------------------

Track Mounted	30,000 - 50,000H
---------------	------------------

CRI	Colors
-----	--------

≥90	<input checked="" type="checkbox"/> Black <input type="checkbox"/> White
-----	--

Input Voltage	Material
---------------	----------

220V AC (with the Attached Built in Driver)	Podwer Coated Aluminum
--	------------------------



Track Linear light

Rotatable Linear

ACU TL 244022

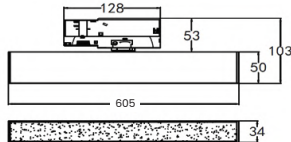

Wattage

24W

Beam Angle

110°

Color Temperature

3000k

Lumen Output

2390 Lm

Installation

Track Mounted

Rated Life Hours

30,000 - 50,000H

CRI

≥90

Colors

■ Black □ White

Input Voltage

220V AC
(with the Attached Built in Driver)

Material

Powder Coated
Aluminum





Adjustable Linear light

PAVO TRACK

Track Adjustable Linear light

Adjustable Linear

ACU TL 244025

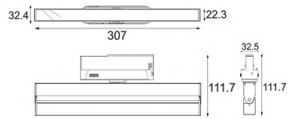

Wattage	Beam Angle
---------	------------

9W	110°
----	------

Color Temperature	Lumen Output
-------------------	--------------

3000k	498 Lm
-------	--------

Installation	Rated Life Hours
--------------	------------------

Track Mounted	30,000 - 50,000H
---------------	------------------

CRI	Colors
-----	--------

≥90	<input checked="" type="checkbox"/> Black <input type="checkbox"/> White
-----	--

Input Voltage	Material
---------------	----------

220V AC (with the Attached Built in Driver)	Podwer Coated Aluminum
--	------------------------



ACU TL 244026

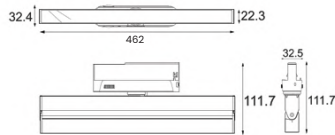
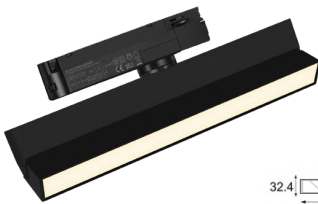

Wattage	Beam Angle
---------	------------

18W	110°
-----	------

Color Temperature	Lumen Output
-------------------	--------------

3000k	1531 Lm
-------	---------

Installation	Rated Life Hours
--------------	------------------

Track Mounted	30,000 - 50,000H
---------------	------------------

CRI	Colors
-----	--------

≥90	<input checked="" type="checkbox"/> Black <input type="checkbox"/> White
-----	--

Input Voltage	Material
---------------	----------

220V AC (with the Attached Built in Driver)	Podwer Coated Aluminum
--	------------------------



Track Adjustable Linear light

Adjustable Linear

ACU TL 244027

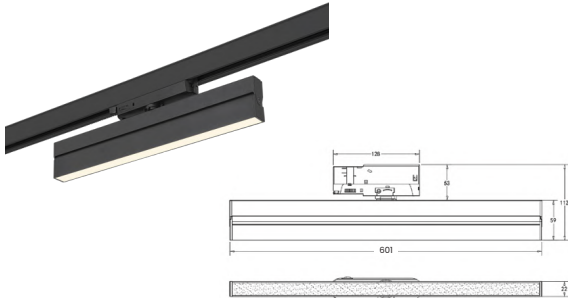

Wattage

24W

Beam angle

110°

Color Temperature

3000k

4000k

Lumen Output

1981Lm

2028Lm

Installation

Track Mounted

Rated life hours

30,000 - 50,000H

CRI

≥90

Colors

■ Black □ White

Input Voltage

220V AC with
(with the Attached Built in Driver)

Material

Podwer Coated
Aluminum



Track Grazer light

Grazer Light

ACU TL 244030

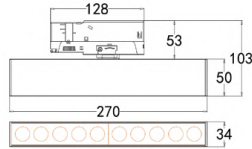

Wattage	Beam Angle
---------	------------

9W	15°, 24°, 38°
----	---------------

Color Temperature	Lumen Output
-------------------	--------------

3000k	521 Lm
-------	--------

Installation	Rated Life Hours
--------------	------------------

Track Mounted	30,000 - 50,000H
---------------	------------------

CRI	Colors
-----	--------

≥90	<input checked="" type="checkbox"/> Black <input type="checkbox"/> White
-----	--

Input Voltage	Material
---------------	----------

220V AC (with the Attached Built in Driver)	Podwer Coated Aluminum
--	------------------------



ACU TL 244031

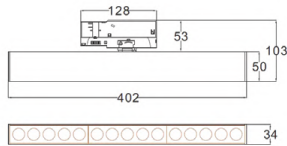

Wattage	Beam Angle
---------	------------

18W	15°, 24°, 38°
-----	---------------

Color Temperature	Lumen Output
-------------------	--------------

3000k	1423 Lm
-------	---------

Installation	Rated Life Hours
--------------	------------------

Track Mounted	30,000 - 50,000H
---------------	------------------

CRI	Colors
-----	--------

≥90	<input checked="" type="checkbox"/> Black <input type="checkbox"/> White
-----	--

Input Voltage	Material
---------------	----------

220V AC (with the Attached Built in Driver)	Podwer Coated Aluminum
--	------------------------



Track Grazer light

Grazer Light

ACU TL 244032

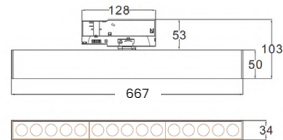

Wattage

24W

Beam Angle

15°

Color Temperature

3000k

Lumen Output

2108 Lm

Installation

Track Mounted

Rated Life Hours

30,000 - 50,000H

CRI

≥90

Colors

■ Black □ White

Input Voltage

220V AC
(with the Attached Built in Driver)

Material

Podwer Coated
Aluminum





Adjustable Grazer light

PAVO TRACK

Track Adjustable Grazer light

Adjustable Grazer Light

ACU TL 244035

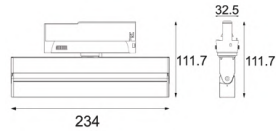

Wattage	Beam Angle
9W	15°
Color Temperature	Lumen Output
3000k	539 Lm
Installation	Rated Life Hours
Track Mounted	30,000 - 50,000H
CRI	Colors
≥90	■ Black □ White
Input Voltage	Material
220V AC (with the Attached Built in Driver)	Podwer Coated Aluminum



ACU TL 244036

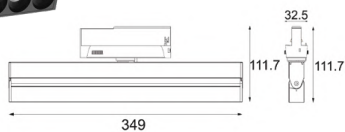

Wattage	Beam Angle
18W	15°
Color Temperature	Lumen Output
3000k	1539 Lm
Installation	Rated Life Hours
Track Mounted	30,000 - 50,000H
CRI	Colors
≥90	■ Black □ White
Input Voltage	Material
220V AC (with the Attached Built in Driver)	Podwer Coated Aluminum





Track Adjustable Grazer light

Adjustable Grazer Light

ACU TL 244037

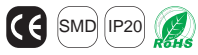
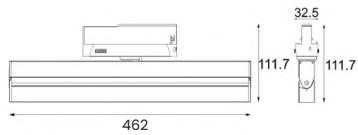

Wattage	Beam Angle
24W	15°
Color Temperature	Lumen Output
3000k	2263 Lm
Installation	Rated Life Hours
Track Mounted	30,000 - 50,000H
CRI	Colors
≥90	■ Black □ White
Input Voltage	Material
220V AC (with the Attached Built in Driver)	Podwer Coated Aluminum



HELENE COLLECTION

PS. Drivers are included with the lights for all operational functions.

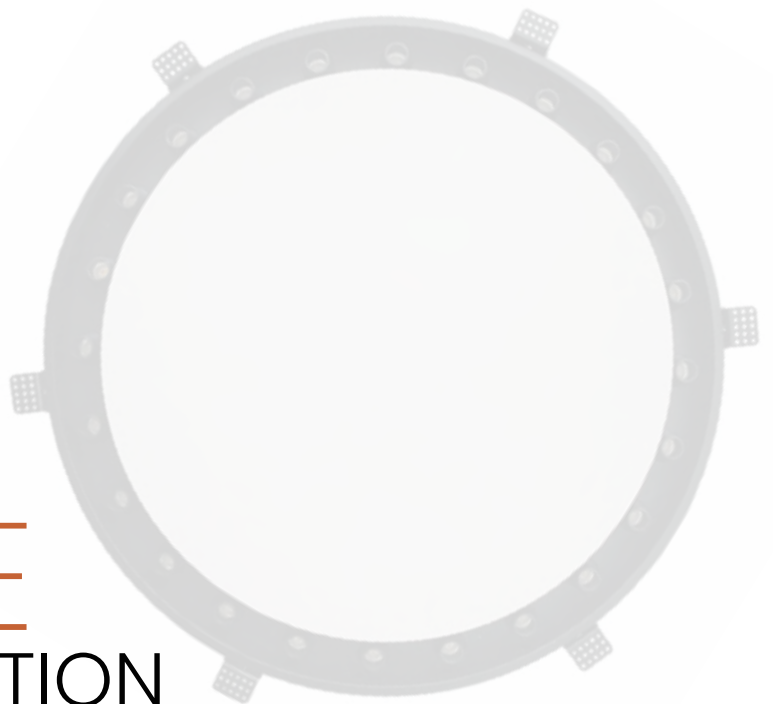

Helene Series

ACU 200801

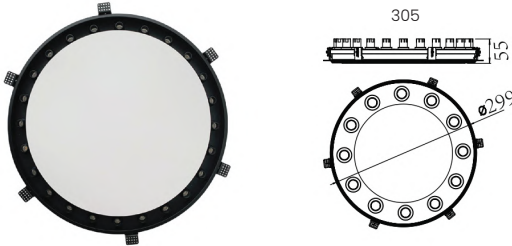

Wattage	Beam Angle
---------	------------

12x2W	12° 24° 36°
-------	-------------

Color Temperature	Lumen Output
-------------------	--------------

3000k	1800 Lm
-------	---------

Installation	Rated Life Hours
--------------	------------------

Trimless Recessed	30,000 - 50,000H
-------------------	------------------

CRI	Colors
-----	--------

≥90	■ Black
-----	---------

Input Voltage	Material
---------------	----------

220V AC (with the Attached Built in Driver)	Powder Coated Aluminium
--	-------------------------

Cutting Section

Cut Out
Ø305mm



ACU 200802

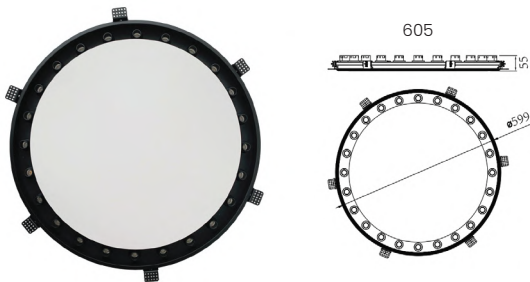

Wattage	Beam Angle
---------	------------

24x2W	12° 24° 36°
-------	-------------

Color Temperature	Lumen Output
-------------------	--------------

3000k	3600 Lm
-------	---------

Installation	Rated Life Hours
--------------	------------------

Trimless Recessed	30,000 - 50,000H
-------------------	------------------

CRI	Colors
-----	--------

≥90	■ Black
-----	---------

Input Voltage	Material
---------------	----------

220V AC (with the Attached Built in Driver)	Powder Coated Aluminium
--	-------------------------

Cutting Section

Cut Out
Ø605mm



Helene Series

ACU 200803

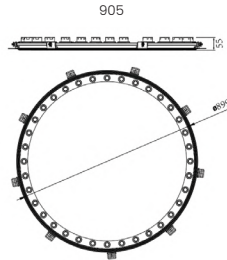

Wattage	Beam Angle
---------	------------

36x2W	12° 24° 36°
-------	-------------

Color Temperature	Lumen Output
-------------------	--------------

3000k	5400 Lm
-------	---------

Installation	Rated Life Hours
--------------	------------------

Trimless Recessed	30,000 - 50,000H
-------------------	------------------

CRI	Colors
-----	--------

≥90	■ Black
-----	---------

Input Voltage	Material
---------------	----------

220V AC (with the Attached Built in Driver)	Powder Coated Aluminium
--	----------------------------

Cutting Section

Cut Out Ø905mm





PONTO COLLECTION

24V DC

Featuring a unified base, effortless installation, and a diverse range that blends general, accent, and decorative lighting—Ponto stands out as the ultimate lighting solution.



Ponto Base

Trimless

ACU BS 24000T

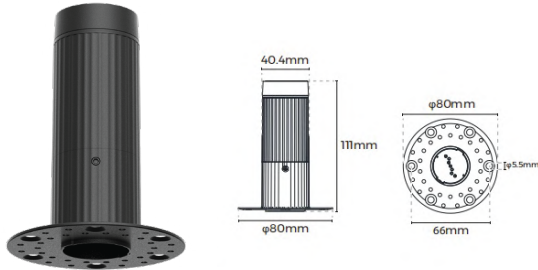

Wattage	Rated Current
---------	---------------

Up to 72W	3A
-----------	----

Open Size	Input voltage
-----------	---------------

φ45mm	24V DC Rated
-------	--------------

Installation	Maximum load
--------------	--------------

Trimless	8Kg
----------	-----

Warranty	Colors
----------	--------

5 years	<input checked="" type="checkbox"/> Black
---------	---

 	<input type="checkbox"/> White
---	--------------------------------

Ponto Base

Recessed

ACU BSC 24000R

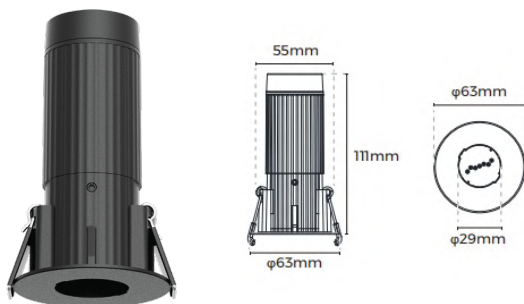

Wattage	Rated Current
---------	---------------

Up to 72W	3A
-----------	----

Open Size	Input voltage
-----------	---------------

φ56mm	24V DC Rated
-------	--------------

Installation	Maximum load
--------------	--------------

Recessed	1Kg
----------	-----

Warranty	Colors
----------	--------

5 years	<input checked="" type="checkbox"/> Black
---------	---

 	<input type="checkbox"/> White
---	--------------------------------

PONTO SPOT LIGHT

Fixed

ACU PS 241000

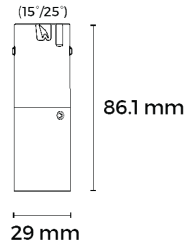

Wattage	Beam Angle
3W	15° 25°
Color Temperature	Lumen Output
3000k	135 Lm
Installation	Rated Life Hours
On Recessed Base	30,000 - 50,000H
CRI	Colors
≥90	■ Black
Input Voltage	
24V DC	



Adjustable

ACU PTS 241001

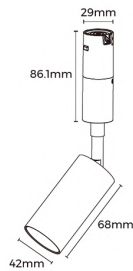

Wattage	Beam Angle
6W	24° 36°
Color Temperature	Lumen Output
3000k	375 Lm
Installation	Rated Life Hours
On Recessed Base	30,000 - 50,000H
CRI	Colors
≥90	■ Black
Input Voltage	
24V DC	



PONTO SPOT LIGHT

Adjustable

ACU PTS 241002

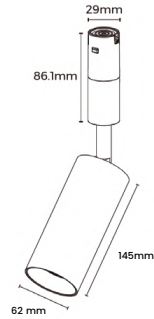

Wattage

14W

Beam Angle

15° 24° 36°

Color Temperature

3000k

Lumen Output

1030 Lm

Installation

On Recessed Base

Rated Life Hours

30,000 - 50,000H

CRI

≥90

Colors

■ Black

Input Voltage

24V DC



PONTO ZOOMABLE LIGHT

ACU PTZ 241101

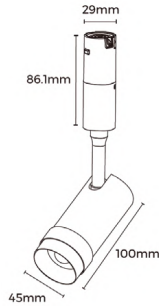

Wattage	Beam Angle
---------	------------

5W	12°-50°
----	---------

Color Temperature	Lumen Output
-------------------	--------------

3000k	282 Lm
-------	--------

Installation	Rated Life Hours
--------------	------------------

On Recessed Base	30,000 - 50,000H
------------------	------------------

CRI	Colors
-----	--------

≥90	■ Black
-----	---------

Input Voltage

24V DC



ACU PTZ 241102

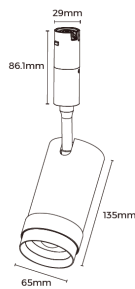

Wattage	Beam Angle
---------	------------

12W	15°-36°
-----	---------

Color Temperature	Lumen Output
-------------------	--------------

3000k	660 Lm
-------	--------

Installation	Rated Life Hours
--------------	------------------

On Recessed Base	30,000 - 50,000H
------------------	------------------

CRI	Colors
-----	--------

≥90	■ Black
-----	---------

Input Voltage

24V DC



PONTO LINEAR

ROUND TUBE LIGHT

ACU PTL 241201

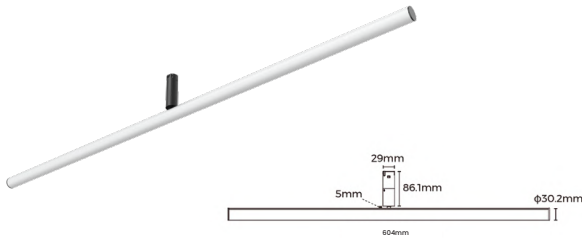

Wattage	Beam Angle
12W	200° x 110°
Color Temperature	Lumen Output
3000k	1128 Lm
Installation	Rated Life Hours
On Recessed Base	30,000 - 50,000H
CRI	Colors
≥90	<input type="checkbox"/> White
Input Voltage	Length
24V DC	604 mm



ACU PTL 241202

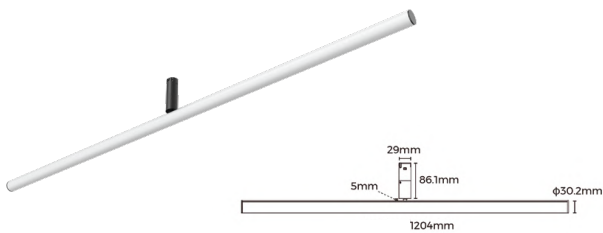

Wattage	Beam Angle
24W	200° x 110°
Color Temperature	Lumen Output
3000k	2256 Lm
Installation	Rated Life Hours
On Recessed Base	30,000 - 50,000H
CRI	Colors
≥90	<input type="checkbox"/> White
Input Voltage	Length
24V DC	1204 mm



PONTO LINEAR

Normal Diffuser

ACU PTL 241301

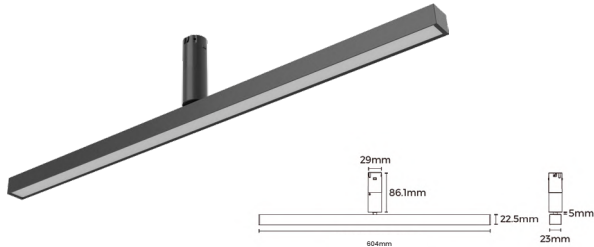

Wattage	Beam Angle
12W	110°
Color Temperature	Lumen Output
3000k	840 Lm
Installation	Rated Life Hours
On Recessed Base	30,000 - 50,000H
CRI	Colors
≥90	■ Black
Input Voltage	Length
24V DC	604 mm



ACU PTL 241302

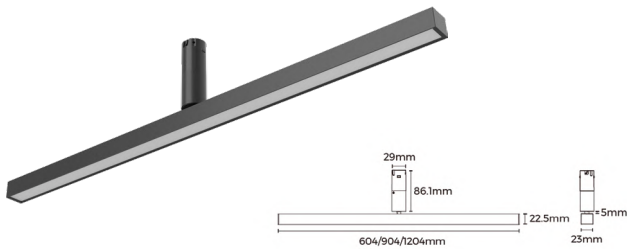

Wattage	Beam Angle
24W	110°
Color Temperature	Lumen Output
3000k	1680 Lm
Installation	Rated Life Hours
On Recessed Base	30,000 - 50,000H
CRI	Colors
≥90	■ Black
Input Voltage	Length
24V DC	1204 mm



PONTO LINEAR

Prismatic Diffuser

ACU PTL 241401

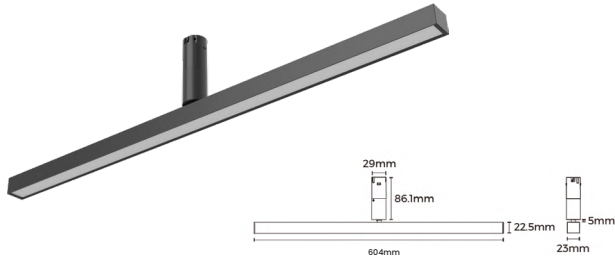

Wattage	Beam Angle
12W	70°
Color Temperature	Lumen Output
3000k	900 Lm
Installation	Rated Life Hours
On Recessed Base	30,000 - 50,000H
CRI	Colors
≥90	■ Black
Input Voltage	Length
24V DC	604 mm



ACU PTL 241402

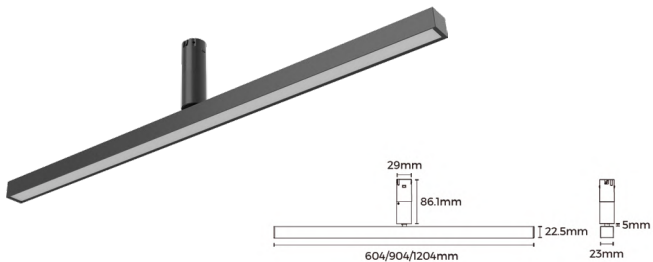

Wattage	Beam Angle
24W	70°
Color Temperature	Lumen Output
3000k	1800 Lm
Installation	Rated Life Hours
On Recessed Base	30,000 - 50,000H
CRI	Colors
≥90	■ Black
Input Voltage	Length
24V DC	1204 mm



PONTO LINEAR

Grating Diffuser

ACU PTL 241501

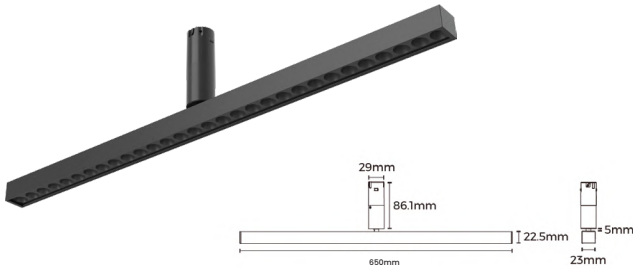

Wattage	Beam Angle
13W	30°
Color Temperature	Lumen Output
3000k	858 Lm
Installation	Rated Life Hours
On Recessed Base	30,000 - 50,000H
CRI	Colors
≥90	■ Black
Input Voltage	Length
24V DC	650 mm



ACU PTL 241502

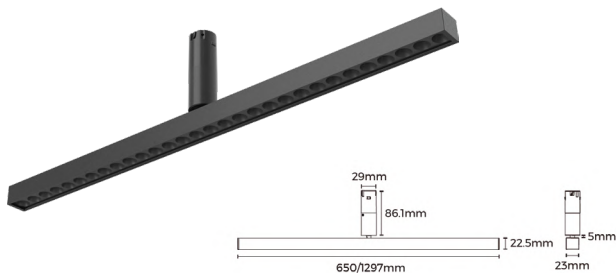

Wattage	Beam Angle
26W	30°
Color Temperature	Lumen Output
3000k	1716 Lm
Installation	Rated Life Hours
On Recessed Base	30,000 - 50,000H
CRI	Colors
≥90	■ Black
Input Voltage	Length
24V DC	1297 mm



PONTO LINEAR

Asymmetric Diffuser

ACU PTL 241601

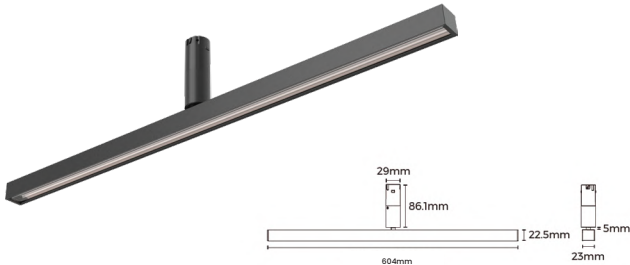

Wattage	Beam Angle
12W	90° x 45° x 15°
Color Temperature	Lumen Output
3000k	1128 Lm
Installation	Rated Life Hours
On Recessed Base	30,000 - 50,000H
CRI	Colors
≥90	■ Black
Input Voltage	Length
24V DC	604 mm



ACU PTL 241602

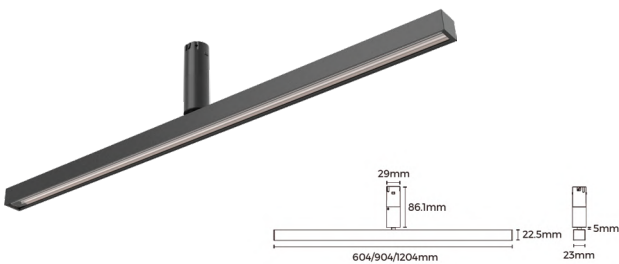

Wattage	Beam Angle
24W	90° x 45° x 15°
Color Temperature	Lumen Output
3000k	2256 Lm
Installation	Rated Life Hours
On Recessed Base	30,000 - 50,000H
CRI	Colors
≥90	■ Black
Input Voltage	Length
24V DC	1204 mm



PONTO LINEAR

Double Asymmetric Diffuser

ACU PTL 241701

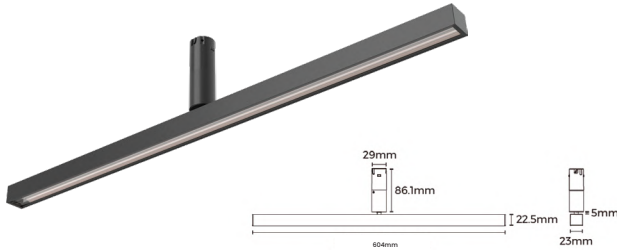

Wattage	Beam Angle
12W	100° x 90° x 15°
Color Temperature	Lumen Output
3000k	1128 Lm
Installation	Rated Life Hours
On Recessed Base	30,000 - 50,000H
CRI	Colors
≥90	■ Black
Input Voltage	Length
24V DC	604 mm



ACU PTL 241702

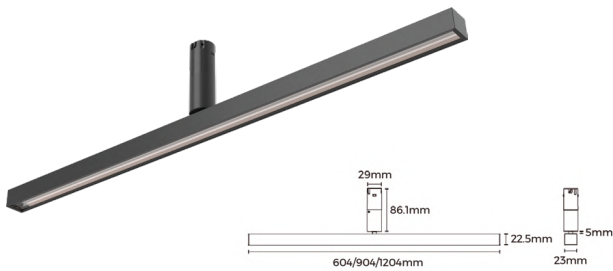

Wattage	Beam Angle
24W	100° x 90° x 15°
Color Temperature	Lumen Output
3000k	2256 Lm
Installation	Rated Life Hours
On Recessed Base	30,000 - 50,000H
CRI	Colors
≥90	■ Black
Input Voltage	Length
24V DC	1204 mm





Up-Down
Ponto Linear Light

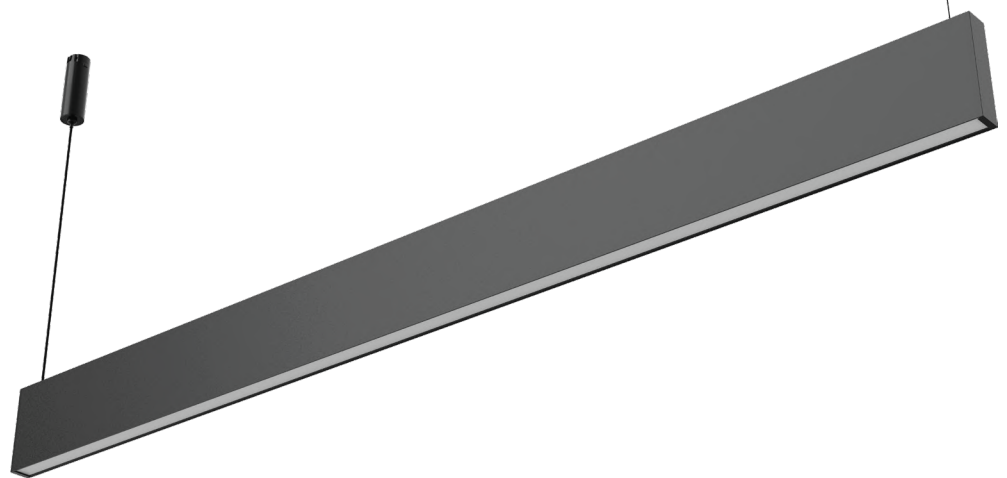

PONTO LINEAR

Normal Diffuser

ACU PTL 241801

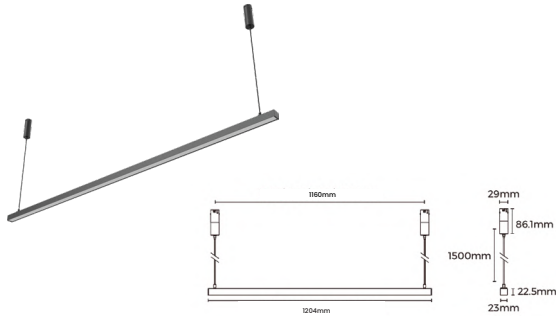

Wattage	Beam Angle
24W	110°
Color Temperature	Lumen Output
3000k	1680 Lm
Installation	Rated Life Hours
On Recessed Base	30,000 - 50,000H
CRI	Colors
≥90	■ Black
Input Voltage	Length
24V DC	1204 mm



PONTO LINEAR

With Prismatic Diffuser

ACU PTL 241901

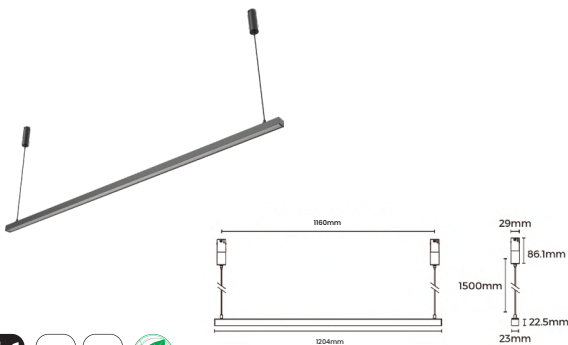

Wattage	Beam Angle
24W	70°
Color Temperature	Lumen Output
3000k	1800 Lm
Installation	Rated Life Hours
On Recessed Base	30,000 - 50,000H
CRI	Colors
≥90	■ Black
Input Voltage	Length
24V DC	1204 mm



PONTO LINEAR

Grating Diffuser

ACU PTL 242001

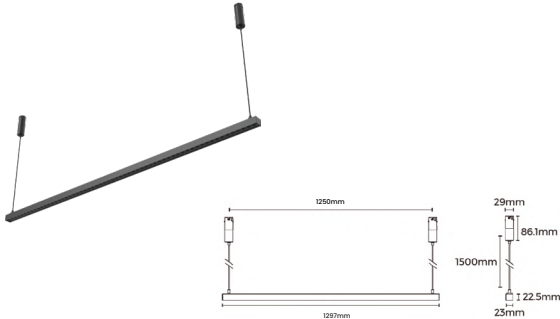

Wattage	Beam Angle
26W	30°
Color Temperature	Lumen Output
3000k	1716 Lm
Installation	Rated Life Hours
On Recessed Base	30,000 - 50,000H
CRI	Colors
≥90	■ Black
Input Voltage	Length
24V DC	1297 mm



UP-DOWN PONTO LINEAR LIGHT

Normal Diffuser

ACU PTL 242101

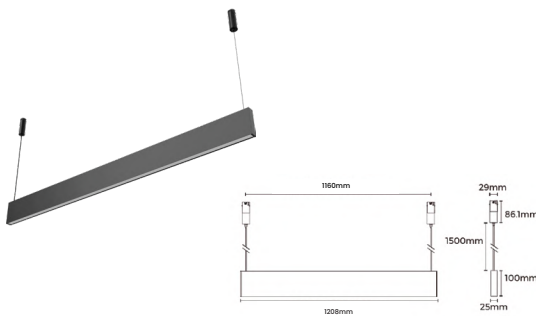

Wattage	Beam Angle
48W	Up: 100° , Down: 100°
Color Temperature	Lumen Output
3000k	2688 Lm
Installation	Rated Life Hours
On Recessed Base	30,000 - 50,000H
CRI	Colors
≥90	■ Black
Input Voltage	Length
24V DC	1208 mm



UP-DOWN PONTO LINEAR LIGHT

Prismatic Diffuser

ACU PTL 242201

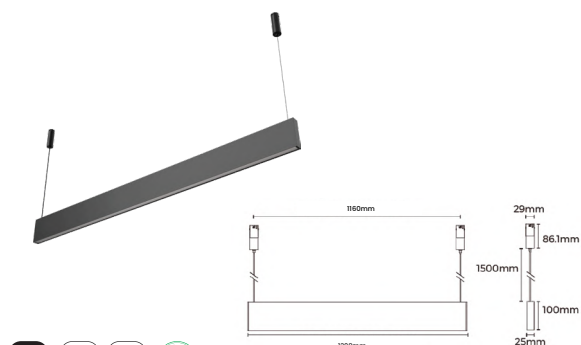

Wattage	Beam Angle
48W	Up: 100° , Down: 100°
Color Temperature	Lumen Output
3000k	2784 Lm
Installation	Rated Life Hours
On Recessed Base	30,000 - 50,000H
CRI	Colors
≥90	■ Black
Input Voltage	Length
24V DC	1208 mm



UP-DOWN PONTO LINEAR LIGHT

Grating Diffuser

ACU PTL 242301

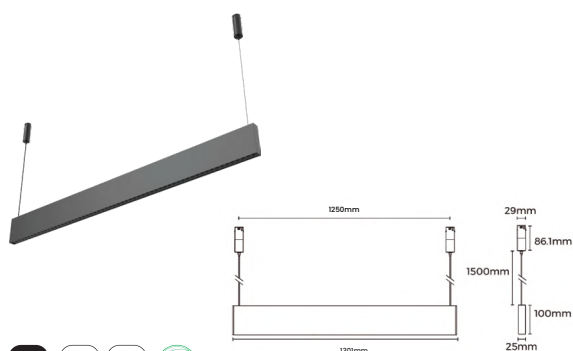

Wattage	Beam Angle
53W	Up:100° , Down: 100°
Color Temperature	Lumen Output
3000k	2703 Lm
Installation	Rated Life Hours
On Recessed Base	30,000 - 50,000H
CRI	Colors
≥90	■ Black
Input Voltage	Length
24V DC	1301 mm



PONTO WALL WASHER

ACU WW 242401

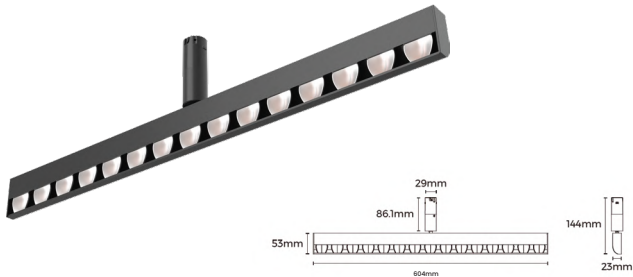

Wattage	Beam Angle
10W	60° X 25° X 73°
Color Temperature	Lumen Output
3000k	846 Lm
Installation	Rated Life Hours
On Recessed Base	30,000 - 50,000H
CRI	Colors
≥90	■ Black
Input Voltage	Length
24V DC	604 mm



ACU WW 242402

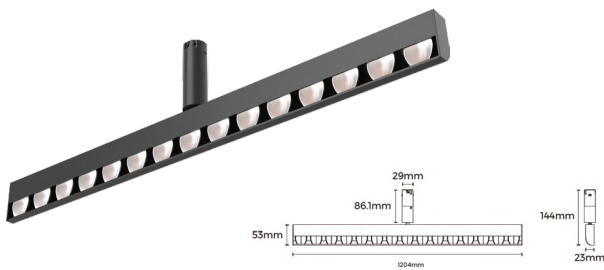

Wattage	Beam Angle
20W	60° X 25° X 73°
Color Temperature	Lumen Output
3000k	1692 Lm
Installation	Rated Life Hours
On Recessed Base	30,000 - 50,000H
CRI	Colors
≥90	■ Black
Input Voltage	Length
24V DC	1204 mm





UP-DOWN PONTO LINEAR LIGHT

Prismatic Diffuser

ACU WW 242501

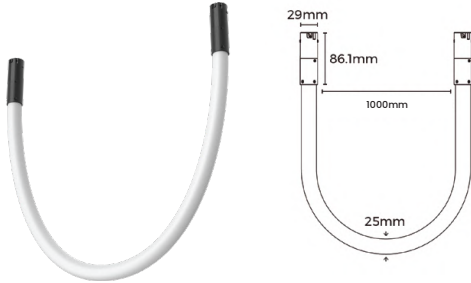

Wattage	Beam Angle
14W	360°
Color Temperature	Lumen Output
3000k	920 Lm
Installation	Rated Life Hours
On Recessed Base	30,000 - 50,000H
CRI	Colors
≥90	<input type="checkbox"/> White
Input Voltage	Length
24V DC	1000 mm



ACU WW 242502

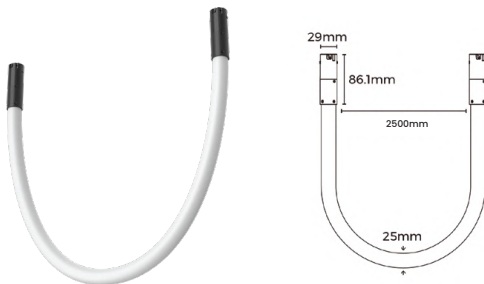

Wattage	Beam Angle
35W	360°
Color Temperature	Lumen Output
3000k	2300 Lm
Installation	Rated Life Hours
On Recessed Base	30,000 - 50,000H
CRI	Colors
≥90	<input type="checkbox"/> White
Input Voltage	Length
24V DC	2500 mm



PONTO ROUND LIGHT

Neon Flex

ACU WW 242503

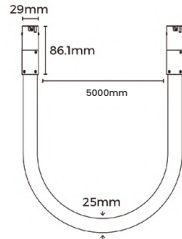

Wattage	Beam Angle
70W	360°
Color Temperature	Lumen Output
3000k	4600 Lm
Installation	Rated Life Hours
On Recessed Base	30,000 - 50,000H
CRI	Colors
≥90	<input type="checkbox"/> White
Input Voltage	Length
24V DC	5000 mm



PONTO DECORATIVE

ACU PTD 242601

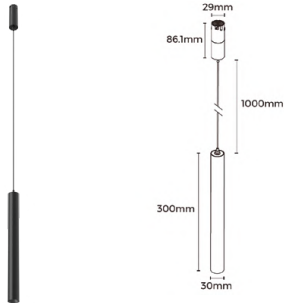

Wattage	Beam Angle
6W	24°
Color Temperature	Lumen Output
3000k	370 Lm
Installation	Rated Life Hours
On Recessed Base	30,000 - 50,000H
CRI	Colors
≥90	■ Black
Input Voltage	Length
24V DC	ADJ Cable



ACU PTD 242602

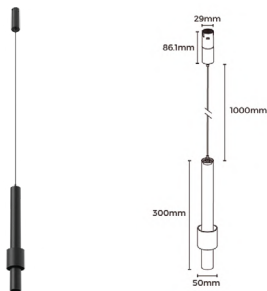

Wattage	Beam Angle
6W	24°
Color Temperature	Lumen Output
3000k	370 Lm
Installation	Rated Life Hours
On Recessed Base	30,000 - 50,000H
CRI	Colors
≥90	■ Black
Input Voltage	Length
24V DC	ADJ Cable





PONTO DECORATIVE

Neon Flex

ACU PTD 242603

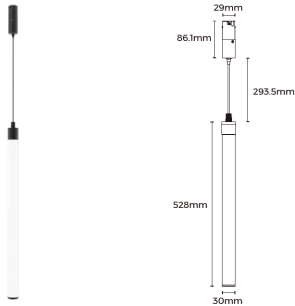

Wattage	Beam Angle
7W	360°
Color Temperature	Lumen Output
3000k	460 Lm
Installation	Rated Life Hours
On Recessed Base	30,000 - 50,000H
CRI	Colors
≥90	■ Black
Input Voltage	Length
24V DC	ADJ Cable



ACU PTD 242604



Wattage	Beam Angle
6W	360°
Color Temperature	Lumen Output
3000k	560 Lm
Installation	Rated Life Hours
On Recessed Base	30,000 - 50,000H
CRI	Colors
≥90	■ Black
Input Voltage	Length
24V DC	ADJ Cable





PONTO DECORATIVE

ACU PTD 242605

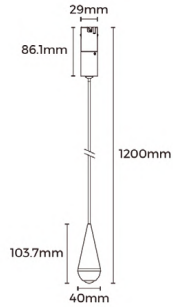

Wattage	Beam Angle
4W	110°
Color Temperature	Lumen Output
3000k	340 Lm
Installation	Rated Life Hours
On Recessed Base	30,000 - 50,000H
CRI	Colors
≥90	■ Black
Input Voltage	Length
24V DC	ADJ Cable



ACU PTD 242606

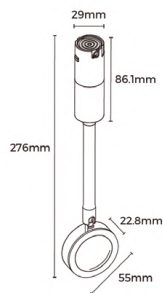

Wattage	Beam Angle
3W	110°
Color Temperature	Lumen Output
3000k	170 Lm
Installation	Rated Life Hours
On Recessed Base	30,000 - 50,000H
CRI	Colors
≥90	■ Black
Input Voltage	Length
24V DC	ADJ Cable





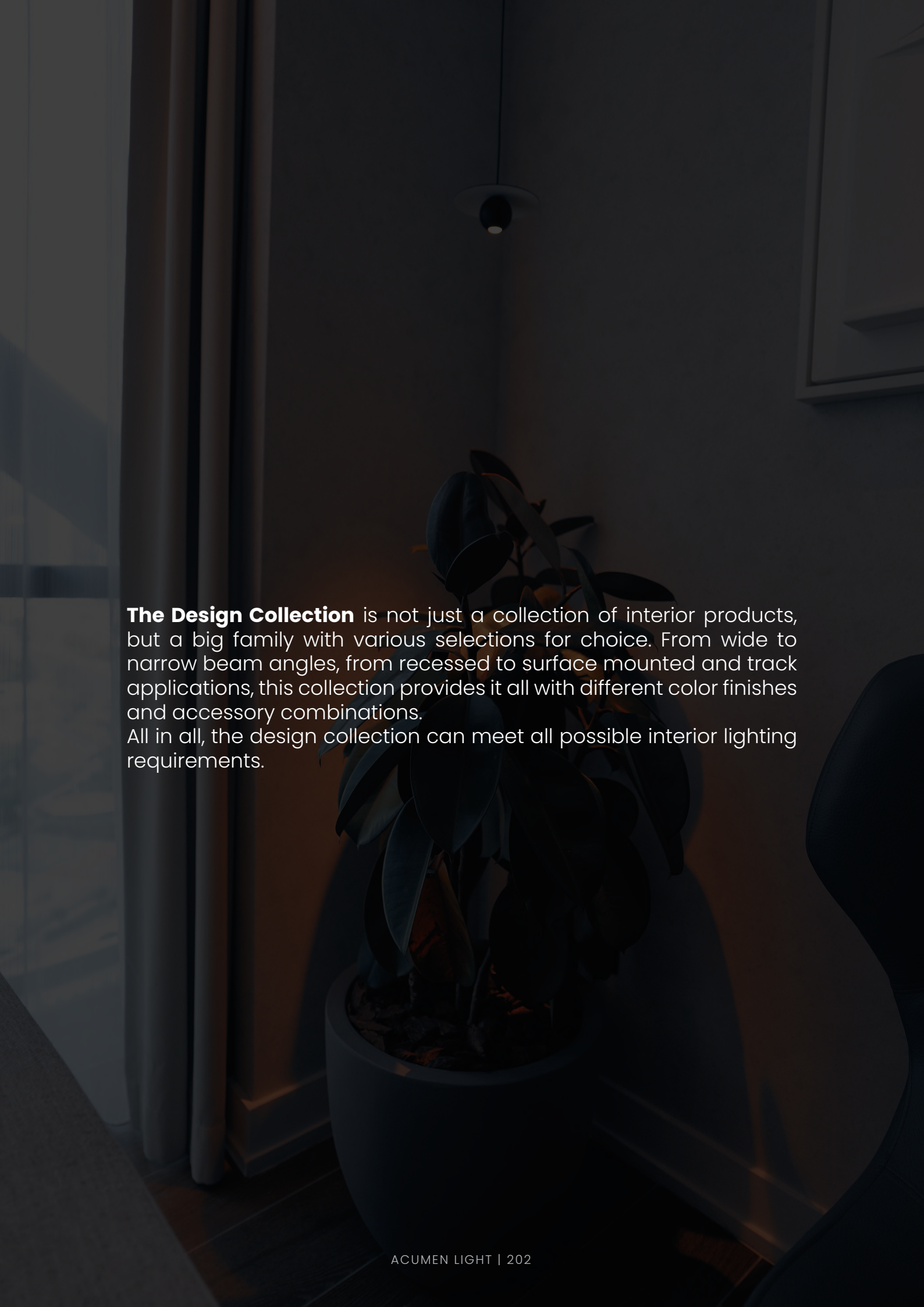

The Design Collection is not just a collection of interior products, but a big family with various selections for choice. From wide to narrow beam angles, from recessed to surface mounted and track applications, this collection provides it all with different color finishes and accessory combinations. All in all, the design collection can meet all possible interior lighting requirements.

DROP COLLECTION

PS. Drivers are included with the lights for all operational functions.

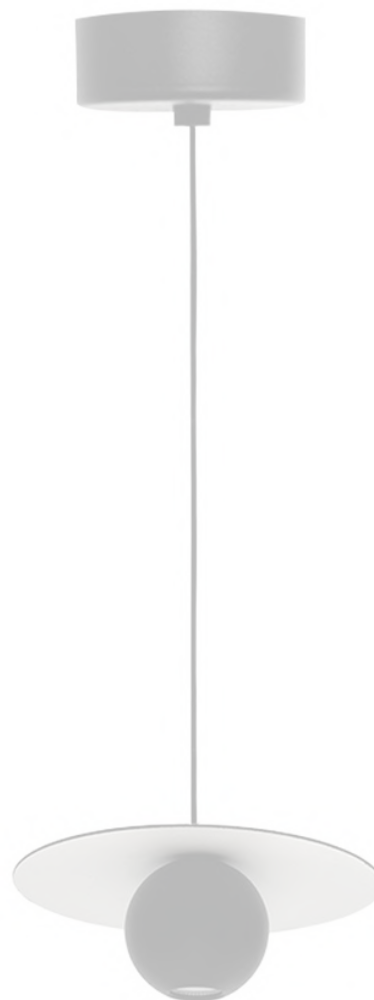



Drop Series

Pendant Light

ACU 238001

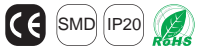
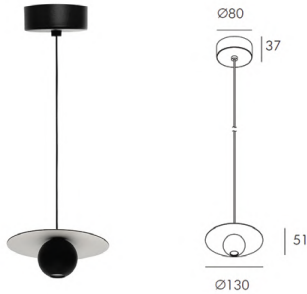

Wattage	Beam Angle
5W	20° 35°
Color Temperature	Lumen Output
3000k	341 Lm
Installation	Rated Life Hours
Suspended	30,000 - 50,000H
CRI	Colors
≥90	■ Black
Input Voltage	Materials
220V AC (with the Attached Built in Driver)	Die Cast Aluminium



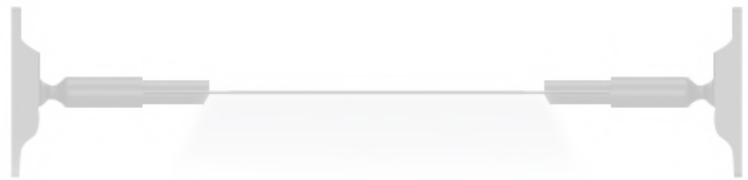

MOONLINE COLLECTION

PS. Drivers are included with the lights for all operational functions.

Moonline Series

ACU MOON 01

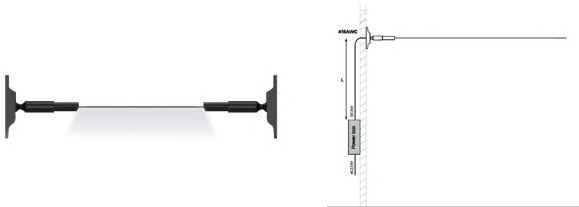

Wattage	Beam Angle
10 W/mW	120°
Color Temperature	Lumen Output
3000k	≈1000 Lm/m
Installation	Rated Life Hours
Point to Point	30,000 - 50,000H
CRI	Colors
≥90	■ Black
Input Voltage	Material
220V AC (with the Attached Built in Driver)	Zinc alloy, spraying surface, steel belt (stainless steel)
Dimention	Cutting Section
L-6000mm	29.41 mm



ACU MOON 02

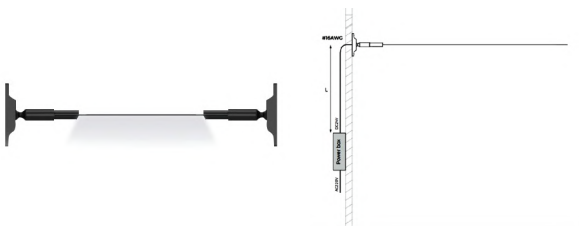

Wattage	Beam Angle
13.5 W/mW	120°
Color Temperature	Lumen Output
3000k	≈1320 Lm/m
Installation	Rated Life Hours
Point to Point	30,000 - 50,000H
CRI	Colors
≥90	■ Black
Input Voltage	Material
220V AC (with the Attached Built in Driver)	Zinc alloy, spraying surface, steel belt (stainless steel)
Dimention	Cutting Section
L-6000mm	50 mm



Moonline Series

ACU MOON 03

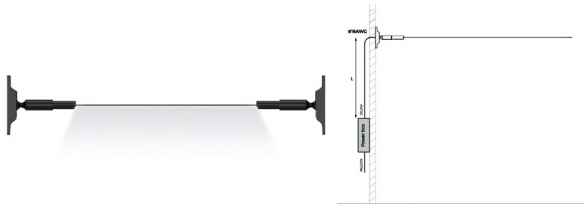

Wattage	8.7 W/mW	Beam Angle	120°
Color Temperature	3000k	Lumen Output	≈890 Lm/m
Installation	Point to Point	Rated Life Hours	30,000 - 50,000H
CRI	≥90	Colors	■ Black
Input Voltage	220V AC (With the Attached Built in Driver)	Material	Zinc alloy, spraying surface, steel belt (stainless steel)
Dimention	L-12000mm	Cutting Section	50 mm



ACU MOON 04

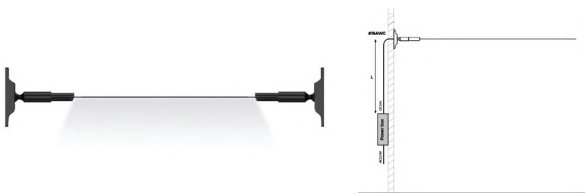

Wattage	8.7 W/mW	Beam Angle	120°
Color Temperature	3000k	Lumen Output	≈890 Lm/m
Installation	Point to Point	Rated Life Hours	30,000 - 50,000H
CRI	≥90	Colors	■ Black
Input Voltage	220V AC (With the Attached Built in Driver)	Material	Zinc alloy, spraying surface, steel belt (stainless steel)
Dimention	L-12000mm	Cutting Section	50 mm







SLEEK COLLECTION

PS. Drivers are included with the lights for all operational functions.

Sleek Series

Pendant Light

ACU 235001

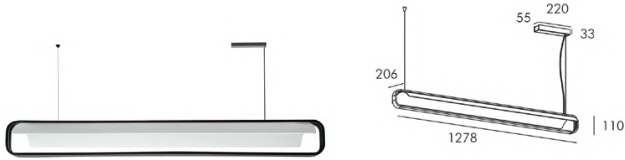

Wattage	Beam Angle
27W	--
Color Temperature	Lumen Output
3000k	Decorative Lumen Effect
Installation	Rated Life Hours
Suspended	30,000 - 50,000H
CRI	Colors
≥90	■ Black □ White
Input Voltage	Material
220V AC (with the Attached Built in Driver)	Die Cast Aluminium



ACU 235002

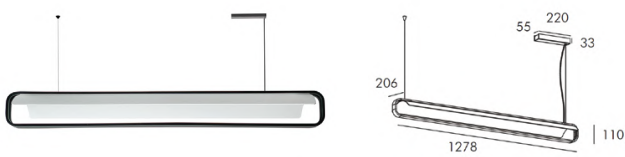

Wattage	Beam Angle
35W	--
Color Temperature	Lumen Output
3000k	Decorative Lumen Effect
Installation	Rated Life Hours
Suspended	30,000 - 50,000H
CRI	Colors
≥90	■ Black □ White
Input Voltage	Material
220V AC (with the Attached Built in Driver)	Die Cast Aluminium



Sleek Series

ACU 235003

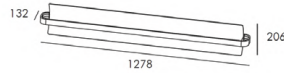
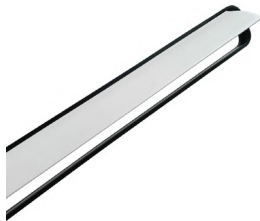

Wattage	Beam Angle
20W	--
Color Temperature	Lumen Output
3000k	Decorative Lumen Effect
Installation	Rated Life Hours
Wall Mounted	30,000 - 50,000H
CRI	Colors
≥90	■ Black □ White
Input Voltage	Material
220V AC (with the Attached Built in Driver)	Die Cast Aluminium



ACU 235004

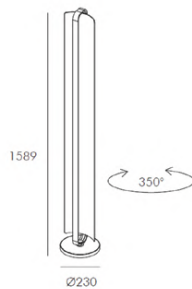

Wattage	Beam Angle
35W	--
Color Temperature	Lumen Output
3000k	Decorative Lumen Effect
Installation	Rated Life Hours
Floor Mounted	30,000 - 50,000H
CRI	Colors
≥90	■ Black □ White
Input Voltage	Material
220V AC (with the Attached Built in Driver)	Die Cast Aluminium



ROTARY DIMMABLE SWITCH



GLANCE COLLECTION

PS. Drivers are included with the lights for all operational functions.

Glance Series

ACU 234001

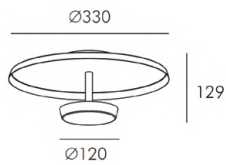

Wattage	Beam Angle
12W	110°
Color Temperature	Lumen Output
3000k	Decorative Lumen Effect
Installation	Rated Life Hours
On Recessed Base	30,000 - 50,000H
CRI	Colors
≥90	■ Black □ White
Input Voltage	Materials
220V AC (with the Attached Built in Driver)	Iron + Aluminum



ACU 234002



Wattage	Beam Angle
12W	360°
Color Temperature	Lumen Output
3000k	Decorative Lumen Effect
Installation	Rated Life Hours
On Recessed Base	30,000 - 50,000H
CRI	Colors
≥90	■ Black □ White
Input Voltage	Materials
220V AC (with the Attached Built in Driver)	Iron + Aluminum





ORION COLLECTION



PS. Drivers are included with the lights for all operational functions.

Orion Series

ACU 236001

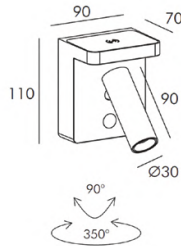

Wattage

7W

Beam Angle

45°

Color Temperature

3000k

Lumen Output

Decorative Lumen Effect

Installation

On Recessed Base

Rated Life Hours

30,000 - 50,000H

CRI

≥90

Colors

■ Black □ White

Input Voltage

220V AC
(with the Attached Built in Driver)

Materials

Die Casting Aluminium



STICK COLLECTION

PS. Drivers are included with the lights for all operational functions.



Stick Series

ACU LS 231101

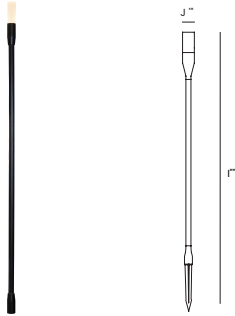

Wattage	Beam Angle
1W	180°
Color Temperature	Lumen Output
3000k	Decorative Lumen Effect
Installation	Rated Life Hours
On Recessed Base	30,000 - 50,000H
CRI	Colors
≥90	■ Black □ White
Input Voltage	Materials
12V AC (Via the Attached Driver)	Aluminum + PC





ACUMEN Outdoor lighting These set of products brighten up and bring life to outdoor spaces of residential and commercial buildings with simple, and elegant modern outdoor lighting fixtures that are designed to illuminate and inspire. It enhances the beauty of any property while providing safety and security.

There are different types, shapes, and styles available, which can match with and add value to architecture and landscapes. Additionally, we offer the opportunity to adjust or select colour temperatures flexibly for various applications. Weather-proof materials will protect the products and maintain their efficient work.

The best lighting solutions conserve less energy, but LED light sources can provide very high luminance levels which may cause glare. For this reason, ACUMEN LED fixtures are commonly equipped with anti-glare accessories to reduce this unpleasant visual effect.

UP LIGHT



The Up light Series for outdoor in-ground installation represent essential fixtures for lighting architectural elements or trees. Different wattage and shape types make the selection of an applicable product easier. Available with special components that provide visual comfort.

Up Light

Surface Mounted

ACU OSM 182015

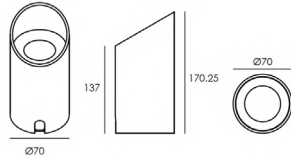

Wattage	Beam Angle
1x5W	18° 23° 24°
Color Temperature	Lumen Output
3000k	≈460 Lm
Installation	Rated Life Hours
Surface Mounted	30,000 - 50,000H
CRI	Colors
≥90	■ Black
Input Voltage	Materials
220V AC (with the Attached Built in Driver)	Powder Coated Aluminum

Recessed Inground

ACU OU 182001M

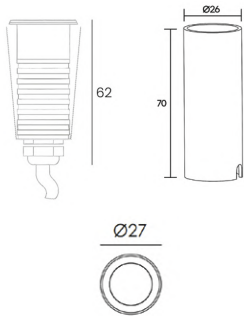

Wattage	Beam Angle
1x0.5W	70°
Color Temperature	Lumen Output
3000k	≈23 Lm
Installation	Rated Life Hours
Recessed Inground	30,000 - 50,000H
CRI	Colors
≥90	■ Chrome Finish
Input Voltage	Materials
24V DC (External Driver)	Stainless Steel Cover with Powder, Coated Aluminum Housing.

Up Light

Recessed Inground

ACU OU 182001MS

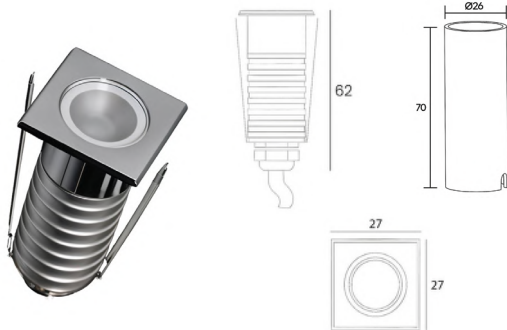

Wattage	Beam Angle
---------	------------

1x0.5W	70°
--------	-----

Color Temperature	Lumen Output
-------------------	--------------

3000k	≈23 Lm
-------	--------

Installation	Rated Life Hours
--------------	------------------

Recessed Inground	30,000 - 50,000H
-------------------	------------------

CRI	Colors
-----	--------

≥90	■ Chrome Finish
-----	-----------------

Input Voltage	Materials
---------------	-----------

24V DC (External Driver)	Stainless Steel Cover with Powder, Coated Aluminum Housing.
-----------------------------	---

ACU OU 182001H



Wattage	Beam Angle
---------	------------

1x0.5W	70°
--------	-----

Color Temperature	Lumen Output
-------------------	--------------

3000k	≈23 Lm
-------	--------

Installation	Rated Life Hours
--------------	------------------

Recessed Inground	30,000 - 50,000H
-------------------	------------------

CRI	Colors
-----	--------

≥90	■ Chrome Finish
-----	-----------------

Input Voltage	Materials
---------------	-----------

24V DC 3V DC	Stainless Steel Cover with Powder, Coated Aluminum Housing.
-----------------	---

Up Light

Recessed Inground

ACU OU 182001SH

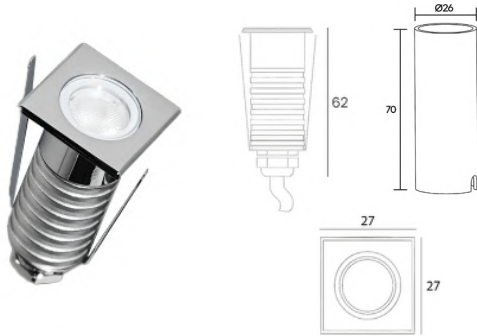

Wattage	Beam Angle
1x1.5W	10° 15° 20° 30°
Color Temperature	Lumen Output
3000k	≈136 Lm
Installation	Rated Life Hours
Recessed Inground	30,000 - 50,000H
CRI	Colors
≥90	■ Chrome Finish
Input Voltage	Materials
24V DC (External Driver)	Stainless Steel Cover with Powder, Coated Aluminum Housing.

ACU OU 182002A

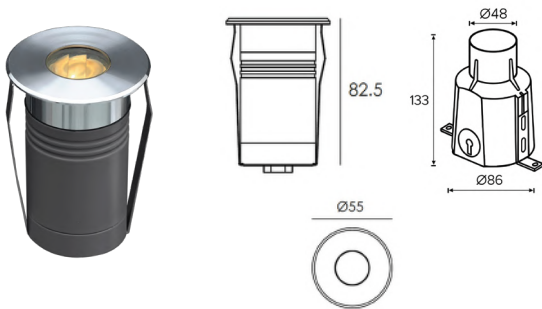

Wattage	Beam Angle
1x2W	35° / 45° Asymmetrical
Color Temperature	Lumen Output
3000k	≈130 Lm
Installation	Rated Life Hours
Recessed Inground	30,000 - 50,000H
CRI	Colors
≥90	■ Chrome Finish
Input Voltage	Materials
220V AC (with the Attached Built in Driver)	Stainless Steel Cover with Powder, Coated Aluminum Housing.



Up Light

Recessed Inground

ACU OU 182002H

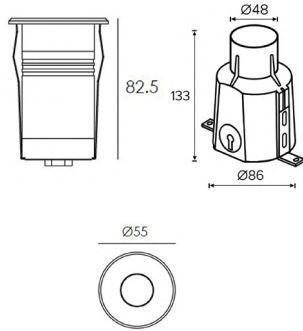

Wattage	Beam Angle
1x2W	15° 20° 30° 45°
Color Temperature	Lumen Output
3000k	≈143 Lm
Installation	Rated Life Hours
Recessed Inground	30,000 - 50,000H
CRI	Colors
≥90	■ Chrome Finish
Input Voltage	Materials
220V AC (with the Attached Built in Driver)	Stainless Steel Cover with Powder, Coated Aluminum Housing.

ACU OU 182002SH

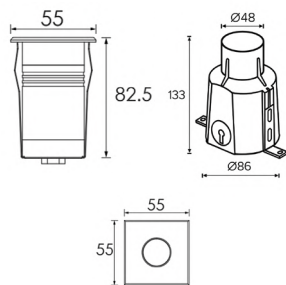

Wattage	Beam Angle
1x2W	9° 15° 20° 30° 45°
Color Temperature	Lumen Output
3000k	≈143 Lm
Installation	Rated Life Hours
Recessed Inground	30,000 - 50,000H
CRI	Colors
≥90	■ Chrome Finish
Input Voltage	Materials
220V AC (with the Attached Built in Driver)	Stainless Steel Cover with Powder, Coated Aluminum Housing.

Up Light

Recessed Inground

ACU OU 182003MH

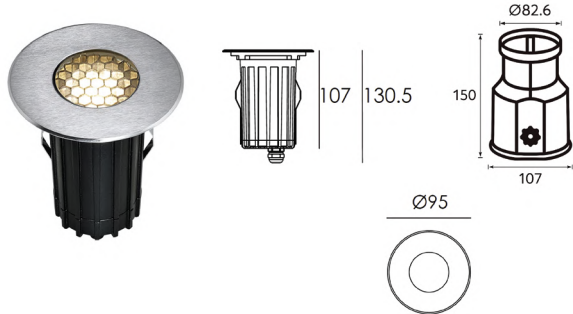

Wattage	Beam Angle
---------	------------

1x4W	9° 15° 20° 30° 45°
------	--------------------

Color Temperature	Lumen Output
-------------------	--------------

3000k	≈441 Lm
-------	---------

Installation	Rated Life Hours
--------------	------------------

Recessed Inground	30,000 - 50,000H
-------------------	------------------

CRI	Colors
-----	--------

≥90	■ Chrome Finish
-----	-----------------

Input Voltage	Materials
---------------	-----------

220V AC (with the Attached Built in Driver)	Stainless Steel Cover with Powder, Coated Aluminum Housing.
--	---

ACU OU 182003MSH

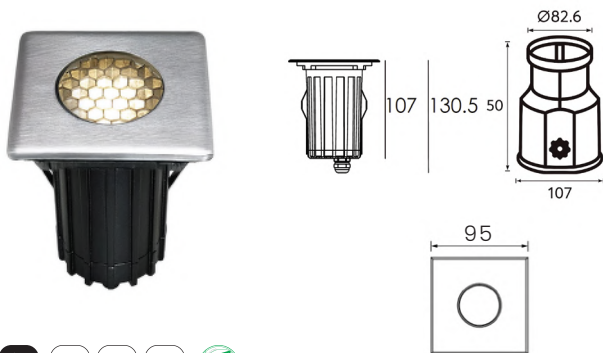

Wattage	Beam Angle
---------	------------

1x4W	9° 15° 20° 30° 45°
------	--------------------

Color Temperature	Lumen Output
-------------------	--------------

3000k	≈441 Lm
-------	---------

Installation	Rated Life Hours
--------------	------------------

Recessed Inground	30,000 - 50,000H
-------------------	------------------

CRI	Colors
-----	--------

≥90	■ Chrome Finish
-----	-----------------

Input Voltage	Materials
---------------	-----------

220V AC (with the Attached Built in Driver)	Stainless Steel Cover with Powder, Coated Aluminum Housing.
--	---



Up Light

Recessed Inground

ACU OU 182003H

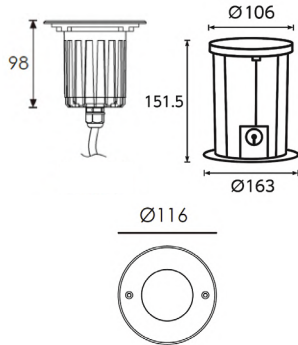

Wattage	Beam Angle
---------	------------

8W	10° 15° 20° 30° 45°
----	---------------------

Color Temperature	Lumen Output
-------------------	--------------

3000k	≈744 Lm
-------	---------

Installation	Rated Life Hours
--------------	------------------

Recessed Inground	30,000 - 50,000H
-------------------	------------------

CRI	Colors
-----	--------

≥90	■ Chrome Finish
-----	-----------------

Input Voltage	Materials
---------------	-----------

220V AC (with the Attached Built in Driver)	Stainless Steel Cover with Powder, Coated Aluminum Housing.
--	---

ACU OU 182003SH

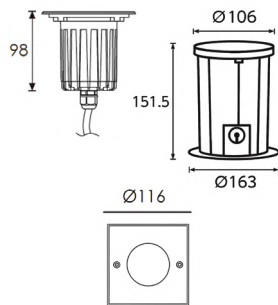

Wattage	Beam Angle
---------	------------

8W	10° 15° 20° 30° 45°
----	---------------------

Color Temperature	Lumen Output
-------------------	--------------

3000k	≈744 Lm
-------	---------

Installation	Rated Life Hours
--------------	------------------

Recessed Inground	30,000 - 50,000H
-------------------	------------------

CRI	Colors
-----	--------

≥90	■ Chrome Finish
-----	-----------------

Input Voltage	Materials
---------------	-----------

220V AC (with the Attached Built in Driver)	Stainless Steel Cover with Powder, Coated Aluminum Housing.
--	---

Up Light

Recessed Inground

ACU OU 182004H

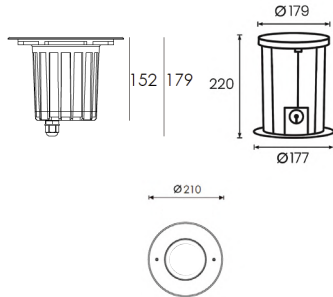

Wattage	Beam Angle
18W	10° 15° 20° 30°
Color Temperature	Lumen Output
3000k	≈1760 Lm
Installation	Rated Life Hours
Recessed Inground	30,000 - 50,000H
CRI	Colors
≥90	■ Chrome Finish
Input Voltage	Materials
220V AC (with the Attached Built in Driver)	Stainless Steel Cover with Powder, Coated Aluminum Housing.

ACU OU 182004SH

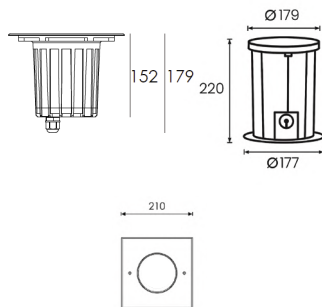

Wattage	Beam Angle
18W	10° 15° 20° 30°
Color Temperature	Lumen Output
3000k	≈1760 Lm
Installation	Rated Life Hours
Recessed Inground	30,000 - 50,000H
CRI	Colors
≥90	■ Chrome Finish
Input Voltage	Materials
220V AC (with the Attached Built in Driver)	Stainless Steel Cover with Powder, Coated Aluminum Housing.

Up Light

Recessed Inground

ACU OU 182005H

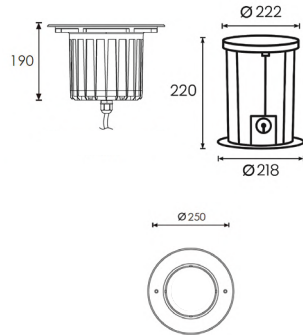

Wattage	Beam Angle
---------	------------

25W	10° 15° 20° 30°
-----	-----------------

Color Temperature	Lumen Output
-------------------	--------------

3000k	≈3000 Lm
-------	----------

Installation	Rated Life Hours
--------------	------------------

Recessed Inground	30,000 - 50,000H
-------------------	------------------

CRI	Colors
-----	--------

≥90	■ Chrome Finish
-----	-----------------

Input Voltage	Materials
---------------	-----------

220V AC (with the Attached Built in Driver)	Stainless Steel Cover with Powder, Coated Aluminum Housing.
--	---

ACU OU 182005SH

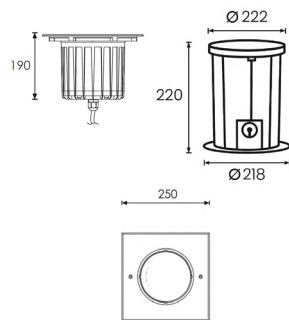

Wattage	Beam Angle
---------	------------

25W	10° 15° 20° 30°
-----	-----------------

Color Temperature	Lumen Output
-------------------	--------------

3000k	≈3000 Lm
-------	----------

Installation	Rated Life Hours
--------------	------------------

Recessed Inground	30,000 - 50,000H
-------------------	------------------

CRI	Colors
-----	--------

≥90	■ Chrome Finish
-----	-----------------

Input Voltage	Materials
---------------	-----------

220V AC (with the Attached Built in Driver)	Stainless Steel Cover with Powder, Coated Aluminum Housing.
--	---



Up Light

Recessed Inground / Adjustable

ACU OU 182006H

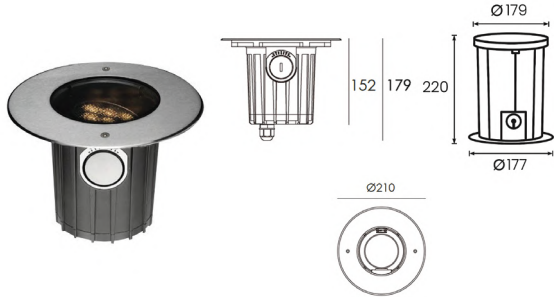

Wattage	Beam Angle
---------	------------

9x1.2W	10° 15° 20° 30° 50°
--------	---------------------

Color Temperature	Lumen Output
-------------------	--------------

3000k	≈756 Lm
-------	---------

Installation	Rated Life Hours
--------------	------------------

Recessed Inground	30,000 - 50,000H
-------------------	------------------

CRI	Colors
-----	--------

≥90	■ Chrome Finish
-----	-----------------

Input Voltage	Materials
---------------	-----------

220V AC (with the Attached Built in Driver)	Stainless Steel Cover with Powder, Coated Aluminum Housing.
--	---

ACU OU 182006SH

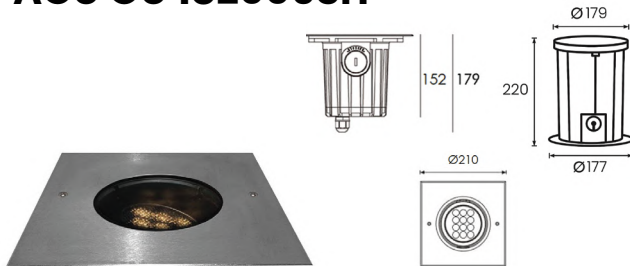

Wattage	Beam Angle
---------	------------

9x1.2W	15° 20° 30° 50°
--------	-----------------

Color Temperature	Lumen Output
-------------------	--------------

3000k	≈756 Lm
-------	---------

Installation	Rated Life Hours
--------------	------------------

Recessed Inground	30,000 - 50,000H
-------------------	------------------

CRI	Colors
-----	--------

≥90	■ Chrome Finish
-----	-----------------

Input Voltage	Materials
---------------	-----------

220V AC (with the Attached Built in Driver)	Stainless Steel Cover with Powder, Coated Aluminum Housing.
--	---

Up Light

Recessed Inground / Adjustable

ACU OU 182007H

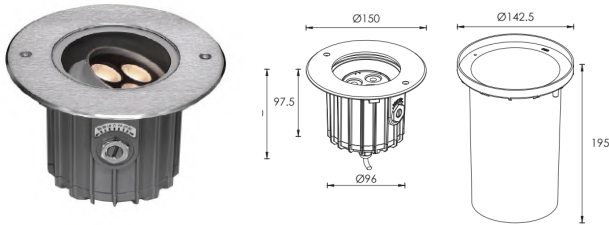

Wattage	Beam Angle
3x2W	9° 15° 20° 30° 45°
Color Temperature	Lumen Output
3000k	282 Lm
Installation	Rated Life Hours
Recessed Inground	30,000 - 50,000H
CRI	Colors
≥90	■ Chrome Finish
Input Voltage	Materials
220V AC (with the Attached Built in Driver)	Stainless Steel Cover with Powder, Coated Aluminum Housing.

Up Light

Wooden Up Light

ACU OU 182009H



Wattage	Beam Angle
1x2W	9° 20°
Color Temperature	Lumen Output
3000k	140 Lm
Installation	Rated Life Hours
Recessed Inground	30,000 - 50,000H
CRI	Colors
≥90	■ Chrome Finish
Input Voltage	Materials
24V DC 220V AC	Stainless Steel Cover with Powder, Coated Aluminum Housing.

Up Light

Wooden Up Light

ACU OU 182010

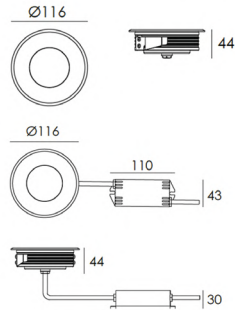
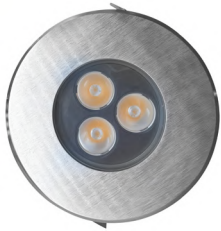

Wattage	Beam Angle
3x2W	9° 15° 20° 30° 45°
Color Temperature	Lumen Output
3000k	388 Lm
Installation	Rated Life Hours
Recessed Inground	30,000 - 50,000H
CRI	Colors
≥90	■ Chrome Finish
Input Voltage	Materials
24V DC 220V AC	Stainless Steel Cover with Powder, Coated Aluminum Housing.

Up Light

Wooden Up Light

ACU OU 182011H

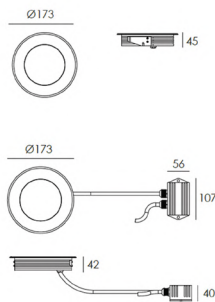

Wattage	Beam Angle
6x2W	15° 30°
Color Temperature	Lumen Output
3000k	977 Lm
Installation	Rated Life Hours
Recessed Inground	30,000 - 50,000H
CRI	Colors
≥90	■ Chrome Finish
Input Voltage	Materials
24V DC 220V AC	Stainless Steel Cover with Powder, Coated Aluminum Housing.

Up Light

Recessed Inground / Adjustable

ACU OU 183003A

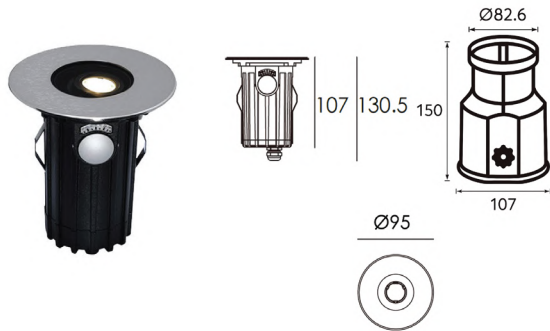

Wattage	Beam Angle
1x2W	15° / 32° Asymmetrical
Color Temperature	Lumen Output
3000k	≈112 Lm
Installation	Rated Life Hours
Recessed Inground	30,000 - 50,000H
CRI	Colors
≥90	■ Chrome Finish
Input Voltage	Materials
220V AC (with the Attached Built in Driver)	Stainless Steel Cover with Powder, Coated Aluminum Housing.

Up Light

Recessed Inground / Adjustable

ACU OU 183003H

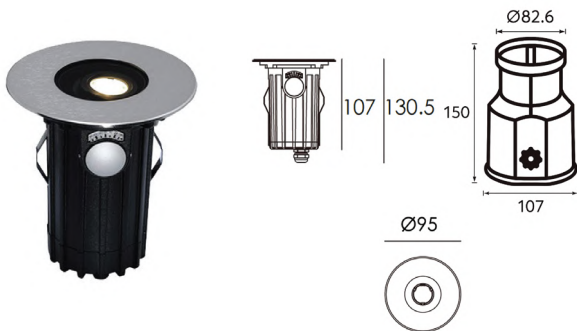

Wattage	Beam Angle
1x2W	13° 20° 25° 30°
Color Temperature	Lumen Output
3000k	≈112 Lm
Installation	Rated Life Hours
Recessed Inground	30,000 - 50,000H
CRI	Colors
≥90	■ Chrome Finish
Input Voltage	Materials
220V AC (with the Attached Built in Driver)	Stainless Steel Cover with Powder, Coated Aluminum Housing.

Up Light

Recessed Inground

ACU OU 183003SH

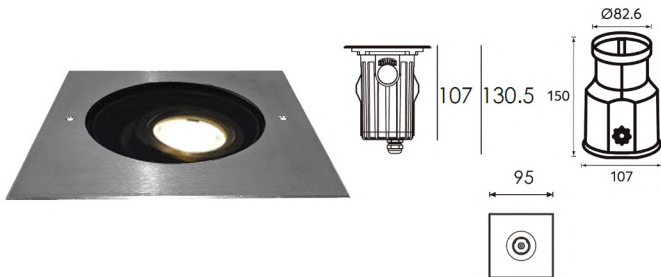

Wattage	Beam Angle
1x2W	13° 25° 30°
Color Temperature	Lumen Output
3000k	≈112 Lm
Installation	Rated Life Hours
Recessed Inground	30,000 - 50,000H
CRI	Colors
≥90	■ Chrome Finish
Input Voltage	Materials
220V AC (with the Attached Built in Driver)	Stainless Steel Cover with Powder, Coated Aluminum Housing.

Up Light

Adjustable

ACU OU 183004H

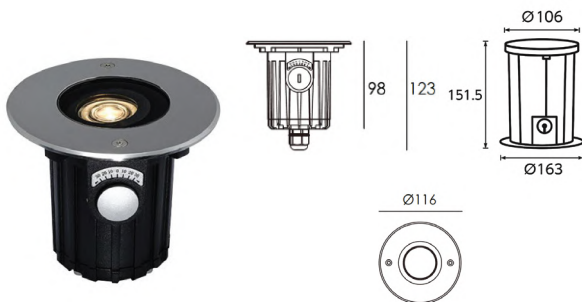

Wattage	Beam Angle
2x1.5W	9° 15° 20° 30°
Color Temperature	Lumen Output
3000k	≈300 Lm
Installation	Rated Life Hours
Recessed Inground	30,000 - 50,000H
CRI	Colors
≥90	■ Chrome Finish
Input Voltage	Materials
220V AC (with the Attached Built in Driver)	Stainless Steel Cover with Powder, Coated Aluminum Housing.

Up Light

Adjustable

ACU OU 183004SH

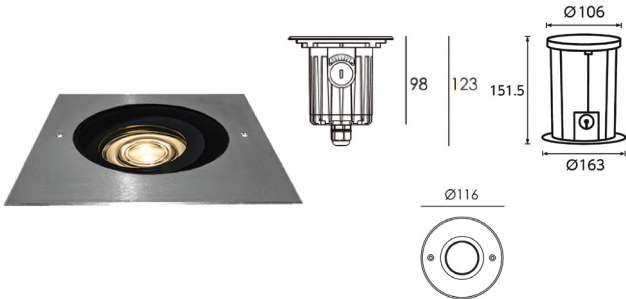

Wattage	Beam Angle
2x1.5W	9° 15° 20° 30°
Color Temperature	Lumen Output
3000k	≈300 Lm
Installation	Rated Life Hours
Recessed Inground	30,000 - 50,000H
CRI	Colors
≥90	■ Chrome Finish
Input Voltage	Materials
220V AC (with the Attached Built in Driver)	Stainless Steel Cover with Powder, Coated Aluminum Housing.

ACU OU 183005H

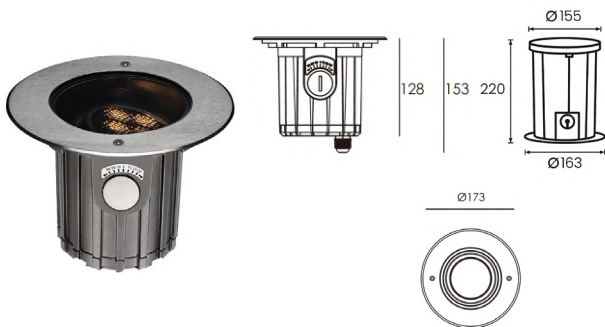

Wattage	Beam Angle
6x1.2W	15° 20° 30° 50°
Color Temperature	Lumen Output
3000k	≈570 Lm
Installation	Rated Life Hours
Recessed Inground	30,000 - 50,000H
CRI	Colors
≥90	■ Chrome Finish
Input Voltage	Materials
220V AC (with the Attached Built in Driver)	Stainless Steel Cover with Powder, Coated Aluminum Housing.

Up Light

Adjustable

ACU OU 183005SH

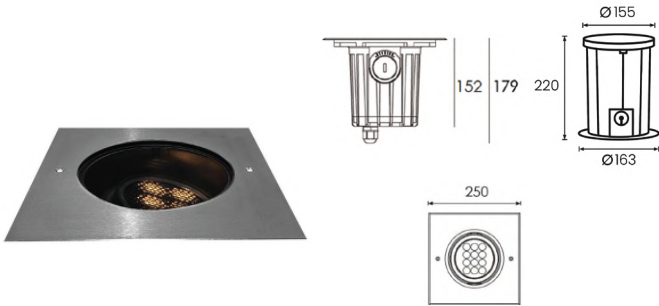

Wattage	Beam Angle
---------	------------

6x1.2W	15° 20° 30° 50°
--------	-----------------

Color Temperature	Lumen Output
-------------------	--------------

3000k	≈570 Lm
-------	---------

Installation	Rated Life Hours
--------------	------------------

Recessed Inground	30,000 - 50,000H
-------------------	------------------

CRI	Colors
-----	--------

≥90	■ Chrome Finish
-----	-----------------

Input Voltage	Materials
---------------	-----------

220V AC (with the Attached Built in Driver)	Stainless Steel Cover with Powder, Coated Aluminum Housing.
--	---

ACU OU 183007H

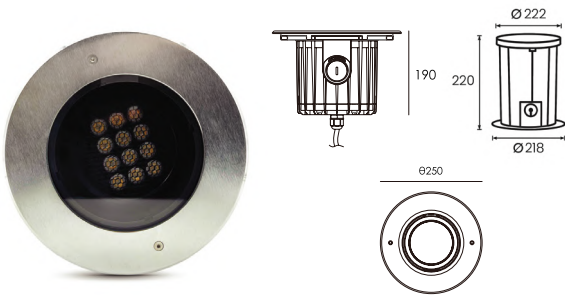

Wattage	Beam Angle
---------	------------

12x1.5W	13° 25° 30°
---------	-------------

Color Temperature	Lumen Output
-------------------	--------------

3000k	≈1389 Lm
-------	----------

Installation	Rated Life Hours
--------------	------------------

Recessed Inground	30,000 - 50,000H
-------------------	------------------

CRI	Colors
-----	--------

≥90	■ Chrome Finish
-----	-----------------

Input Voltage	Materials
---------------	-----------

220V AC (with the Attached Built in Driver)	Stainless Steel Cover with Powder, Coated Aluminum Housing.
--	---

Up Light

Adjustable

ACU OU 183007SH



Wattage	Beam Angle
---------	------------

12x1.5W

13° 25° 30°

Color Temperature	Lumen Output
-------------------	--------------

3000k

≈1389 Lm

Installation	Rated Life Hours
--------------	------------------

Recessed Inground

30,000 - 50,000H

CRI	Colors
-----	--------

≥90

■ Chrome Finish

Input Voltage	Materials
---------------	-----------

220V AC
(with the Attached Built in Driver)

Stainless Steel Cover with Powder, Coated Aluminum Housing.

ACU OU 183008H

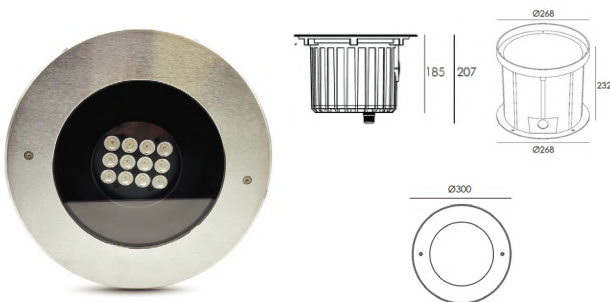

Wattage	Beam Angle
---------	------------

12x1.5W

13° 25° 30°

Color Temperature	Lumen Output
-------------------	--------------

3000k

≈2392 Lm

Installation	Rated Life Hours
--------------	------------------

Recessed Inground

30,000 - 50,000H

CRI	Colors
-----	--------

≥90

■ Chrome Finish

Input Voltage	Materials
---------------	-----------

220V AC
(with the Attached Built in Driver)

Stainless Steel Cover with Powder, Coated Aluminum Housing.





OUTDOOR LINEAR

The Outdoor Linear Series with in-ground and surface mounted installation represent essential fixtures for lighting architectural elements or wall texture. Different wattage and shape types make the selection of an applicable product easier.

Available with special components that provide visual comfort.

Outdoor Linear

Outdoor Recessed Inground Linear

ACU OL 182020H

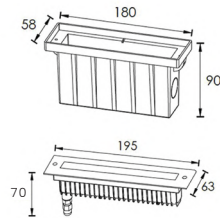

Wattage	Beam Angle
---------	------------

8x0.6W	8° 13° 25° 30°
--------	----------------

Color Temperature	Lumen Output
-------------------	--------------

3000k	≈405 Lm
-------	---------

Installation	Rated Life Hours
--------------	------------------

Recessed Inground	30,000 - 50,000H
-------------------	------------------

CRI	Colors
-----	--------

≥90	■ Chrome Finish
-----	-----------------

Input Voltage	Materials
---------------	-----------

220V AC (with the Attached Built in Driver)	Stainless Steel Cover with Powder, Coated Aluminum Housing.
--	---

ACU OL 182021H

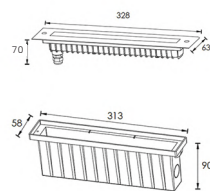

Wattage	Beam Angle
---------	------------

16x2W	8° 13° 25° 30°
-------	----------------

Color Temperature	Lumen Output
-------------------	--------------

3000k	≈838 Lm
-------	---------

Installation	Rated Life Hours
--------------	------------------

Recessed Inground	30,000 - 50,000H
-------------------	------------------

CRI	Colors
-----	--------

≥90	■ Chrome Finish
-----	-----------------

Input Voltage	Materials
---------------	-----------

220V AC (with the Attached Built in Driver)	Stainless Steel Cover with Powder, Coated Aluminum Housing.
--	---

Outdoor Linear

Outdoor Recessed Inground Linear

ACU OL 182021A

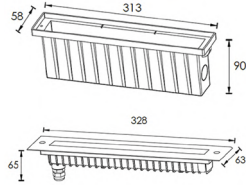

Wattage

6x2W

Beam Angle

Asymmetrical 45° x 35°

Color Temperature

3000k

Lumen Output

≈570 Lm

Installation

Recessed Inground

Rated Life Hours

30,000 - 50,000H

CRI

≥90

Colors

■ Chrome Finish

Input Voltage

220V AC
(with the Attached Built in Driver)

Materials

Stainless Steel Cover
with Powder, Coated
Aluminum Housing.



Outdoor Linear

Outdoor Recessed Inground Linear

ACU OL 182022H

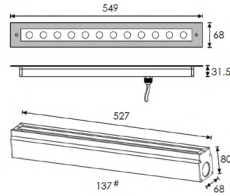

Wattage	Beam Angle
---------	------------

12x1.5W	8° 20° 25° 30° 35° 45°
---------	------------------------

Color Temperature	Lumen Output
-------------------	--------------

3000k	≈1020 Lm
-------	----------

Installation	Rated Life Hours
--------------	------------------

Recessed Inground	30,000 - 50,000H
-------------------	------------------

CRI	Colors
-----	--------

≥90	■ Chrome Finish
-----	-----------------

Input Voltage	Materials
---------------	-----------

220V AC (with the Attached Built in Driver)	Stainless Steel Cover with Powder, Coated Aluminum Housing.
--	---

ACU OL 182022A

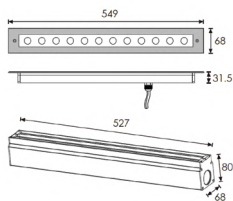

Wattage	Beam Angle
---------	------------

12x1.5W	Asymmetrical 45° x 35°
---------	------------------------

Color Temperature	Lumen Output
-------------------	--------------

3000k	≈1020 Lm
-------	----------

Installation	Rated Life Hours
--------------	------------------

Recessed Inground	30,000 - 50,000H
-------------------	------------------

CRI	Colors
-----	--------

≥90	■ Chrome Finish
-----	-----------------

Input Voltage	Materials
---------------	-----------

220V AC (with the Attached Built in Driver)	Stainless Steel Cover with Powder, Coated Aluminum Housing.
--	---

Outdoor Linear

Outdoor Recessed Inground Linear

ACU OL 182023H

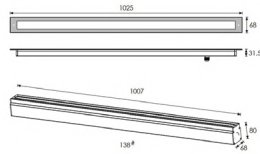

Wattage	Beam Angle
24x1.5W	20° 25° 30° 35° 45°
Color Temperature	Lumen Output
3000k	≈2055 Lm
Installation	Rated Life Hours
Recessed Inground	30,000 - 50,000H
CRI	Colors
≥90	■ Chrome Finish
Input Voltage	Materials
220V AC (with the Attached Built in Driver)	Stainless Steel Cover with Powder, Coated Aluminum Housing.

ACU OL 182023A

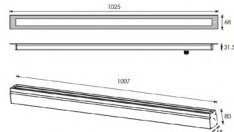

Wattage	Beam Angle
24x1.5W	Asymmetrical 45° x 35°
Color Temperature	Lumen Output
3000k	≈2114 Lm
Installation	Rated Life Hours
Recessed Inground	30,000 - 50,000H
CRI	Colors
≥90	■ Chrome Finish
Input Voltage	Materials
220V AC (with the Attached Built in Driver)	Stainless Steel Cover with Powder, Coated Aluminum Housing.



Outdoor Linear

Outdoor Surface Mounted Linear

ACU OL 182024

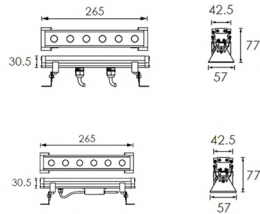

Wattage	Beam Angle
---------	------------

6x1W	15° 20° 30° 50°
------	-----------------

Color Temperature	Lumen Output
-------------------	--------------

3000k	≈512 Lm
-------	---------

Installation	Rated Life Hours
--------------	------------------

Surface Mounted	30,000 - 50,000H
-----------------	------------------

CRI	Colors
-----	--------

≥90	■ Chrome Finish
-----	-----------------

Input Voltage	Materials
---------------	-----------

220V AC (with the Attached Built in Driver)	Stainless Steel Cover with Powder, Coated Aluminum Housing.
--	---

ACU OL 182025

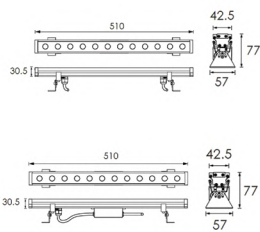

Wattage	Beam Angle
---------	------------

12x1W	15° 20° 30° 50°
-------	-----------------

Color Temperature	Lumen Output
-------------------	--------------

3000k	≈864 Lm
-------	---------

Installation	Rated Life Hours
--------------	------------------

Surface Mounted	30,000 - 50,000H
-----------------	------------------

CRI	Colors
-----	--------

≥90	■ Chrome Finish
-----	-----------------

Input Voltage	Materials
---------------	-----------

220V AC (with the Attached Built in Driver)	Stainless Steel Cover with Powder, Coated Aluminum Housing.
--	---

Outdoor Linear

Outdoor Surface Mounted Linear

ACU OL 182026

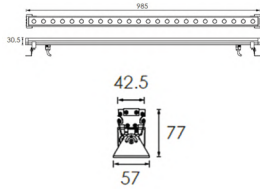

Wattage	Beam Angle
6x1W	15° 20° 30° 50°
Color Temperature	Lumen Output
3000k	≈1976 Lm
Installation	Rated Life Hours
Surface Mounted	30,000 - 50,000H
CRI	Colors
≥90	■ Chrome Finish
Input Voltage	Materials
220V AC (with the Attached Built in Driver)	Stainless Steel Cover with Powder, Coated Aluminum Housing.

ACU OL 182031

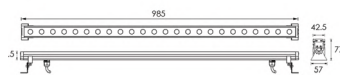

Wattage	Beam Angle
48W	30°
Color Temperature	Lumen Output
3000k	≈2139 Lm
Installation	Rated Life Hours
Surface Mounted	30,000 - 50,000H
CRI	Colors
≥90	■ Chrome Finish
Input Voltage	Materials
220V AC (with the Attached Built in Driver)	Stainless Steel Cover with Powder, Coated Aluminum Housing.

Outdoor Linear

Outdoor Recessed Inground Linear

ACU OL 182080H

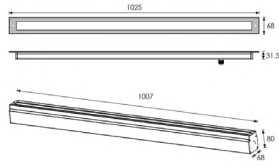

Wattage	Beam Angle
---------	------------

18W	13° 20° 25° 30° 35°
-----	---------------------

Color Temperature	Lumen Output
-------------------	--------------

3000k	≈1359 Lm
-------	----------

Installation	Rated Life Hours
--------------	------------------

Recessed Inground	30,000 - 50,000H
-------------------	------------------

CRI	Colors
-----	--------

≥90	■ Chrome Finish
-----	-----------------

Input Voltage	Materials
---------------	-----------

220V AC (with the Attached Built in Driver)	Stainless Steel Cover with Powder, Coated Aluminum Housing.
--	---

ACU OL 182081H

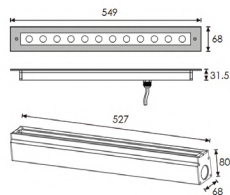

Wattage	Beam Angle
---------	------------

9W	20° 25° 30° 35°
----	-----------------

Color Temperature	Lumen Output
-------------------	--------------

3000k	≈650 Lm
-------	---------

Installation	Rated Life Hours
--------------	------------------

Recessed Inground	30,000 - 50,000H
-------------------	------------------

CRI	Colors
-----	--------

≥90	■ Chrome Finish
-----	-----------------

Input Voltage	Materials
---------------	-----------

220V AC (with the Attached Built in Driver)	Stainless Steel Cover with Powder, Coated Aluminum Housing.
--	---

Outdoor Linear

Outdoor Recessed Inground Linear

ACU OL 182082H

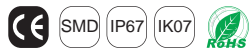
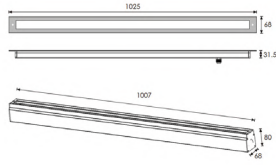

Wattage	Beam Angle
9W	13° 20°
Color Temperature	Lumen Output
3000k	≈650 Lm
Installation	Rated Life Hours
Recessed Inground	30,000 - 50,000H
CRI	Colors
≥90	■ Chrome Finish
Input Voltage	Materials
220V AC (with the Attached Built in Driver)	Stainless Steel Cover with Powder, Coated Aluminum Housing.



DRIVE OVER

Designed for outdoor pathways, this guide light combines sleek functionality with an IK10 rating, ensuring reliable performance in high-traffic environments.

DRIVE OVER

ACU OU 182012

One Way

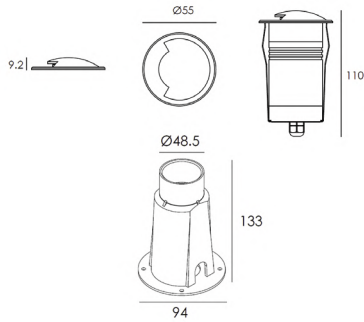
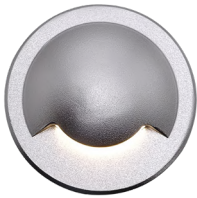

Wattage	Beam Angle
---------	------------

1x2W	120°
------	------

Color Temperature	Lumen Output
-------------------	--------------

3000k	≈13Lm
-------	-------

Installation	Rated Life Hours
--------------	------------------

Recessed	30,000 - 50,000H
----------	------------------

CRI	Colors
-----	--------

≥90	■ Chrome Finish
-----	-----------------

Input Voltage	Materials
---------------	-----------

220V AC (with the Attached Built in Driver)	Stainless Steel Cover with Powder, Coated Aluminum Housing.
--	---

ACU OU 182013

Two Way

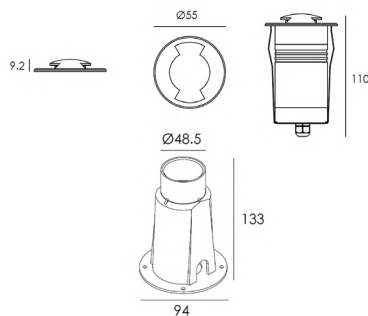
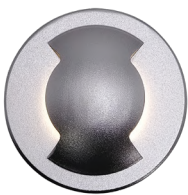

Wattage	Beam Angle
---------	------------

1x2W	100°
------	------

Color Temperature	Lumen Output
-------------------	--------------

3000k	≈10 Lm
-------	--------

Installation	Rated Life Hours
--------------	------------------

Recessed	30,000 - 50,000H
----------	------------------

CRI	Colors
-----	--------

≥90	■ Chrome Finish
-----	-----------------

Input Voltage	Materials
---------------	-----------

220V AC (with the Attached Built in Driver)	Stainless Steel Cover with Powder, Coated Aluminum Housing.
--	---



DRIVE OVER

ACU OU 182014

Four Way

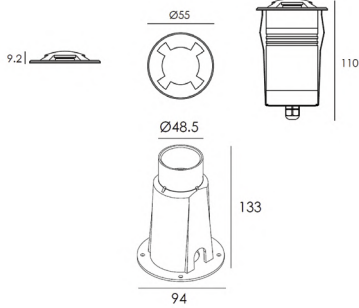

Wattage	Beam Angle
1x2W	54°
Color Temperature	Lumen Output
3000k	≈8.5Lm
Installation	Rated Life Hours
Recessed	30,000 - 50,000H
CRI	Colors
≥90	■ Chrome Finish
Input Voltage	Materials
220V AC (with the Attached Built in Driver)	Stainless Steel Cover with Powder, Coated Aluminum Housing.

WALL & STAIR LIGHT

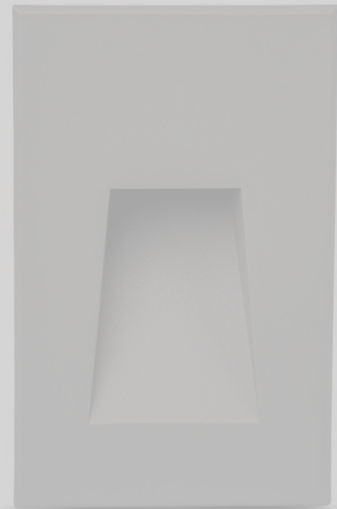

Wall and Stair light outdoor series create a welcoming atmosphere by highlighting features of a building or structure. A variety of shapes and styles contribute to the overall architectural design of the building

Wall & Stair

ACU OSR 182036

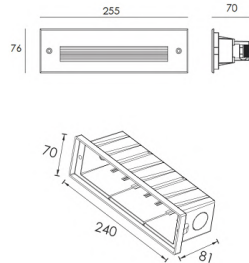

Wattage	Beam Angle
5.7W	N/A
Color Temperature	Lumen Output
3000k	≈104 Lm
Installation	Rated Life Hours
Recessed	30,000 - 50,000H
CRI	Colors
≥90	■ Grey
Input Voltage	Materials
220V AC (with the Attached Built in Driver)	Die Casting Powder Coated Aluminum.

ACU OSR 182037

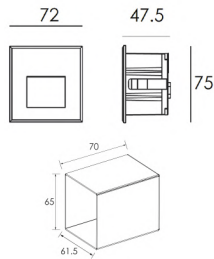

Wattage	Beam Angle
3x0.7W	120°
Color Temperature	Lumen Output
3000k	≈36 Lm
Installation	Rated Life Hours
Recessed Inground	30,000 - 50,000H
CRI	Colors
≥90	■ Black □ White ■ Grey
Input Voltage	Materials
220V AC (with the Attached Built in Driver)	Die Casting Powder Coated Aluminum.

Wall & Stair

ACU OSR 182038

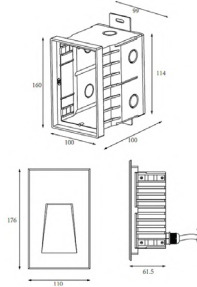

Wattage	18x0.2W	Beam Angle	120°
Color Temperature	3000k	Lumen Output	≈85 Lm
Installation	Recessed	Rated Life Hours	30,000 - 50,000H
CRI	≥90	Colors	■ Black ■ Grey
Input Voltage	220V AC (with the Attached Built in Driver)	Materials	Die Casting Powder Coated Aluminum.

ACU OSR 182039

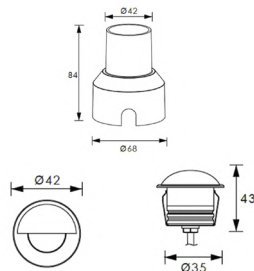

Wattage	1x1W	Beam Angle	32°
Color Temperature	3000k	Lumen Output	≈23 Lm
Installation	Recessed Inground	Rated Life Hours	30,000 - 50,000H
CRI	≥90	Colors	■ Grey
Input Voltage	24V DC	Materials	Die Casting Powder Coated Aluminum.

Wall & Stair

ACU OSR 182040

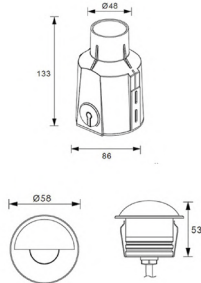

Wattage	Beam Angle
1x2W	22°
Color Temperature	Lumen Output
3000k	≈51 Lm
Installation	Rated Life Hours
Recessed	30,000 - 50,000H
CRI	Colors
≥90	■ Grey
Input Voltage	Materials
24V DC	Die Casting Powder Coated Aluminum.

ACU OSR 182041

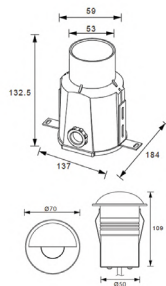

Wattage	Beam Angle
1x5W	18° 24° 32°
Color Temperature	Lumen Output
3000k	≈208 Lm
Installation	Rated Life Hours
Recessed	30,000 - 50,000H
CRI	Colors
≥90	■ Grey
Input Voltage	Materials
24V DC	Die Casting Powder Coated Aluminum.



Wall & Stair

ACU OSR 216001

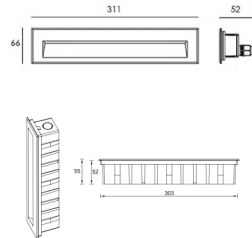

Wattage	Beam Angle
30x0.3W	N/A
Color Temperature	Lumen Output
3000k	≈400 Lm
Installation	Rated Life Hours
Wall Mounted	30,000 - 50,000H
CRI	Colors
≥90	■ Grey
Input Voltage	Materials
220V AC (with the Attached Built in Driver)	Die-casting Aluminum

ACU OSR 216002

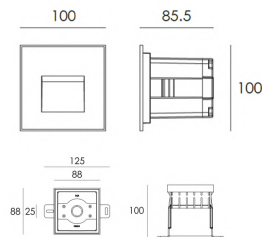

Wattage	Beam Angle
10x0.5W	N/A
Color Temperature	Lumen Output
3000k	≈112 Lm
Installation	Rated Life Hours
Wall Mounted	30,000 - 50,000H
CRI	Colors
≥90	■ Grey
Input Voltage	Materials
220V AC (with the Attached Built in Driver)	Die-casting Aluminum

Wall & Stair

ACU OSR 216003R

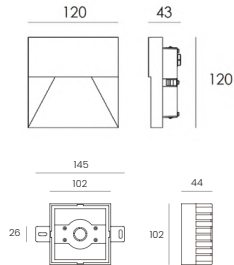
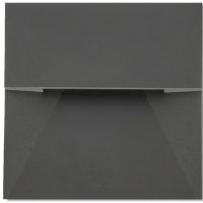

Wattage	Beam Angle
9x0.5W	N/A
Color Temperature	Lumen Output
3000k	≈158 Lm
Installation	Rated Life Hours
Wall Mounted	30,000 - 50,000H
CRI	Colors
≥90	■ Grey
Input Voltage	Materials
220V AC (with the Attached Built in Driver)	Die-casting Aluminum

ACU OSM 216003S

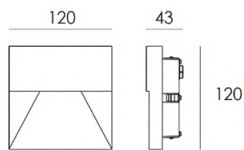
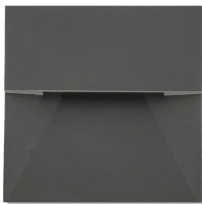

Wattage	Beam Angle
9x0.5W	N/A
Color Temperature	Lumen Output
3000k	≈158 Lm
Installation	Rated Life Hours
Wall Mounted	30,000 - 50,000H
CRI	Colors
≥90	■ Grey
Input Voltage	Materials
220V AC (with the Attached Built in Driver)	Die-casting Aluminum



Wall & Stair

ACU OSR 216004

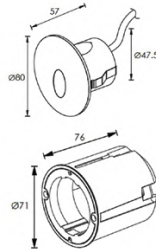

Wattage	Beam Angle
1W	80°
Color Temperature	Lumen Output
3000k	≈46 Lm
Installation	Rated Life Hours
Wall Mounted	30,000 - 50,000H
CRI	Colors
≥90	■ Grey
Input Voltage	Materials
220V AC (with the Attached Built in Driver)	Stainless Steel Cover with Matt Cover

ACU OSR 216005

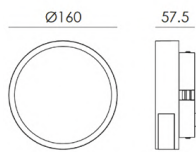

Wattage	Beam Angle
12x0.5W	N/A
Color Temperature	Lumen Output
3000k	≈127Lm
Installation	Rated Life Hours
Wall Mounted	30,000 - 50,000H
CRI	Colors
≥90	■ Grey
Input Voltage	Materials
220V AC (with the Attached Built in Driver)	Die-casting Aluminum

Wall & Stair

ACU OW 182042

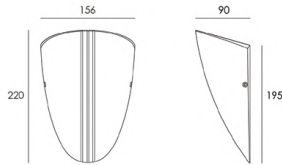

Wattage	Beam Angle
1x6W	10°
1x12W	25°
Color Temperature	Lumen Output
3000k	≈44 Lm
Installation	Rated Life Hours
Wall Mounted	30,000 - 50,000H
CRI	Colors
≥90	■ Black ■ Grey
Input Voltage	Materials
220V AC (with the Attached Built in Driver)	Stainless Steel Cover with Matt Cover

ACU OW 182043

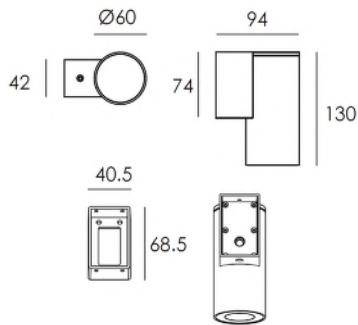

Wattage	Beam Angle
1x4.5W	15° 24° 38°
Color Temperature	Lumen Output
3000k	≈282Lm
Installation	Rated Life Hours
Wall Mounted	30,000 - 50,000H
CRI	Colors
≥90	■ Grey
Input Voltage	Materials
220V AC (with the Attached Built in Driver)	Die Casting Powder Coated Aluminum

Wall & Stair

ACU OW 182044

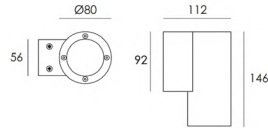

Wattage	Beam Angle
1x10W	15° 24° 38° 60°
Color Temperature	Lumen Output
3000k	≈1170 Lm
Installation	Rated Life Hours
Wall Mounted	30,000 - 50,000H
CRI	Colors
≥90	■ Grey
Input Voltage	Materials
220V AC (with the Attached Built in Driver)	Die Casting Powder Coated Aluminum

ACU OW 182045

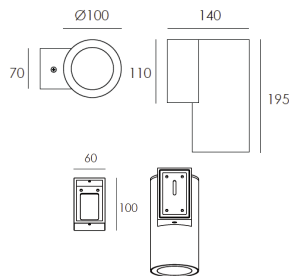

Wattage	Beam Angle
1x18W	12° 22° 38° 55°
Color Temperature	Lumen Output
3000k	≈1847Lm
Installation	Rated Life Hours
Wall Mounted	30,000 - 50,000H
CRI	Colors
≥90	■ Grey
Input Voltage	Materials
220V AC (with the Attached Built in Driver)	Die Casting Powder Coated Aluminum



Wall & Stair

ACU OW 182046

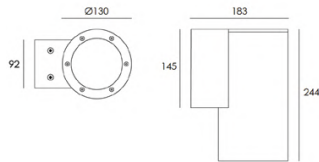

Wattage	Beam Angle
1x25W	10° 22° 38°
Color Temperature	Lumen Output
3000k	≈2967 Lm
Installation	Rated Life Hours
Wall Mounted	30,000 - 50,000H
CRI	Colors
≥90	■ Grey
Input Voltage	Materials
220V AC (with the Attached Built in Driver)	Die Casting Powder Coated Aluminum

ACU OW 182047

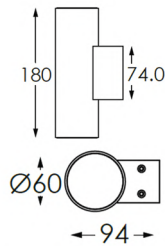

Wattage	Beam Angle
2x4.5W	15° 24° 38°
Color Temperature	Lumen Output
3000k	254x2Lm
Installation	Rated Life Hours
Wall Mounted	30,000 - 50,000H
CRI	Colors
≥90	■ Black ■ Grey
Input Voltage	Materials
220V AC (with the Attached Built in Driver)	Die Casting Powder Coated Aluminum



Wall & Stair

ACU OW 182048

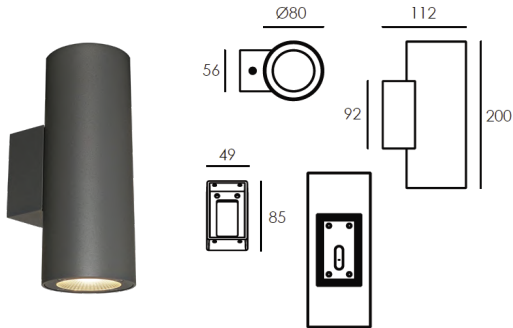

Wattage	Beam Angle
2X8W	15° 24° 38° 60°
Color Temperature	Lumen Output
3000k	≈1972 Lm
Installation	Rated Life Hours
Wall Mounted	30,000 - 50,000H
CRI	Colors
≥90	■ Grey
Input Voltage	Materials
220V AC (with the Attached Built in Driver)	Die Casting Powder Coated Aluminum

ACU OW 182049

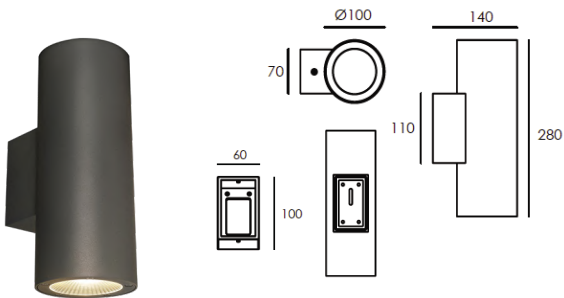

Wattage	Beam Angle
2X12W	12° 22° 38° 55°
Color Temperature	Lumen Output
3000k	≈2158Lm
Installation	Rated Life Hours
Wall Mounted	30,000 - 50,000H
CRI	Colors
≥90	■ Grey
Input Voltage	Materials
220V AC (with the Attached Built in Driver)	Die Casting Powder Coated Aluminum

Wall & Stair

ACU OW 182050

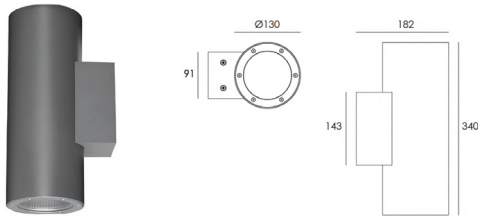

Wattage	Beam Angle
2x18W	10° 22° 38°
Color Temperature	Lumen Output
3000k	≈4072 Lm
Installation	Rated Life Hours
Wall Mounted	30,000 - 50,000H
CRI	Colors
≥90	■ Grey
Input Voltage	Materials
220V AC (with the Attached Built in Driver)	Die Casting Powder Coated Aluminum

ACU OW 182051

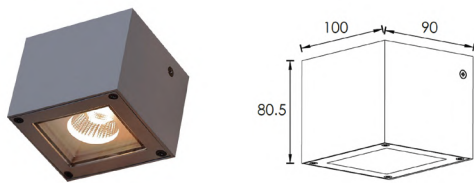

Wattage	Beam Angle
1x6W	18° 25° 40°
Color Temperature	Lumen Output
3000k	≈651 Lm
Installation	Rated Life Hours
Wall Mounted	30,000 - 50,000H
CRI	Colors
≥90	■ Black □ White ■ Grey
Input Voltage	Materials
220V AC (with the Attached Built in Driver)	Die Casting Powder Coated Aluminum.

Wall & Stair

ACU OW 182051N

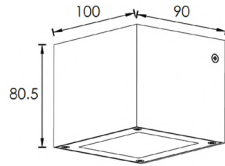
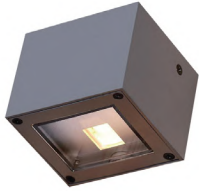

Wattage	Beam Angle
1x3W	10°
Color Temperature	Lumen Output
3000k	≈68 Lm
Installation	Rated Life Hours
Wall Mounted	30,000 - 50,000H
CRI	Colors
≥90	■ Black ■ Grey
Input Voltage	Materials
220V AC (with the Attached Built in Driver)	Die Casting Powder Coated Aluminum

ACU OW 182052

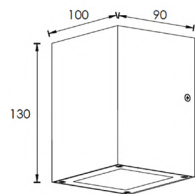

Wattage	Beam Angle
2x6W	18° 25° 40°
Color Temperature	Lumen Output
3000k	≈13021 Lm
Installation	Rated Life Hours
Wall Mounted	30,000 - 50,000H
CRI	Colors
≥90	■ Grey
Input Voltage	Materials
220V AC (with the Attached Built in Driver)	Die Casting Powder Coated Aluminum

Wall & Stair

ACU OW 182052N

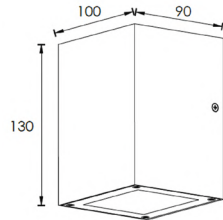

Wattage	Beam Angle
2x3W	10°
Color Temperature	Lumen Output
3000k	≈69 Lm
Installation	Rated Life Hours
Wall Mounted	30,000 - 50,000H
CRI	Colors
≥90	■ Black □ White ■ Grey
Input Voltage	Materials
220V AC (with the Attached Built in Driver)	Die Casting Powder Coated Aluminum.

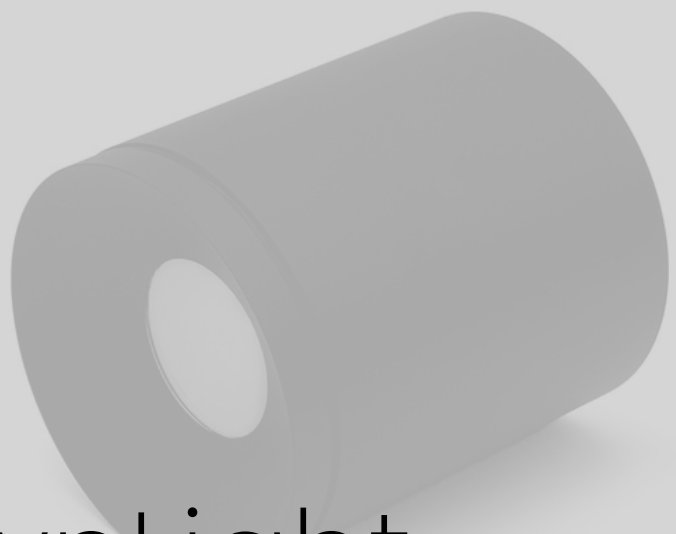

Outdoor DownLight

Outdoor ultra-thin downlight designed to be handy, simple, weather proof and easy to install.

The anti-glare system provides visual comfort for the user.

Ceiling

Surface Mounted

ACU OSM 208101

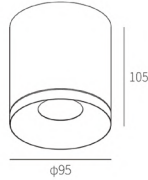

Wattage	Beam Angle
15W	15° 24° 36° 60°
Color Temperature	Lumen Output
3000k	≈1271 Lm
Installation	Rated Life Hours
Surface Mounted	30,000 - 50,000H
CRI	Colors
≥90	■ Black □ White
Input Voltage	Material
220V AC (with the Attached Built in Driver)	Podwer Coated Aluminum

SELEX

Recessed

ACU OD 255001

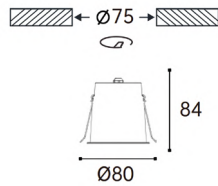

Wattage	Beam Angle
7W	15° 24° 36° 50°
Color Temperature	Lumen Output
3000k	≈700 Lm
Installation	Rated Life Hours
Recessed	30,000 - 50,000H
CRI	Colors
≥90	■ Black □ White
Input Voltage	Material
220V AC (with the Attached Built in Driver)	Podwer Coated Aluminum

SELEX

Recessed

ACU OD 255002

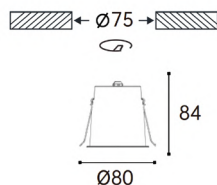

Wattage	Beam Angle
10W	15° 24° 36° 50°
Color Temperature	Lumen Output
3000k	≈1000 Lm
Installation	Rated Life Hours
Recessed	30,000 - 50,000H
CRI	Colors
≥90	■ Black □ White
Input Voltage	Material
220V AC (with the Attached Built in Driver)	Podwer Coated Aluminum

ACU OD 255003

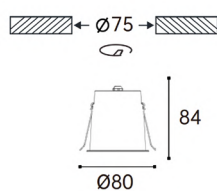

Wattage	Beam Angle
15W	15° 24° 36° 50°
Color Temperature	Lumen Output
3000k	≈1500 Lm
Installation	Rated Life Hours
Recessed	30,000 - 50,000H
CRI	Colors
≥90	■ Black □ White
Input Voltage	Material
220V AC (with the Attached Built in Driver)	Podwer Coated Aluminum



SELEX

Recessed

ACU OD 255004

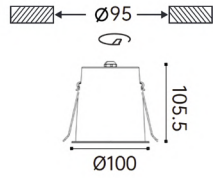

Wattage	Beam Angle
20W	15° 24° 36° 50°
Color Temperature	Lumen Output
3000k	≈1000 Lm
Installation	Rated Life Hours
Recessed	30,000 - 50,000H
CRI	Colors
≥90	■ Black □ White
Input Voltage	Material
220V AC (with the Attached Built in Driver)	Podwer Coated Aluminum

NEON FLEX

Outdoor strip lighting offers a sleek, modern solution for indirect illumination. It is easy to install, energy-efficient, and designed to enhance any exterior space with subtle, continuous lighting.



Neon Flex

Side Bend

ACU ST 202201

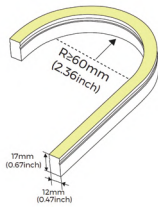

Wattage	10.6 W/m	Beam angle	N/A
Color Temperature	2700K 3000k 4000k	Lumen Output	410 Lm/m 450 Lm/m 420 Lm/m
Installation	Neon Flex Accessories Profile & Clips	Rated life hours	36000H
CRI	≥90	Colors	<input type="checkbox"/> White
Input Voltage	24V DC	Material	Neon Flex
Dimension	W 12mm x H 17mm	Cutting Section	50mm / 7 LEDs

ACU ST 202202-RGB

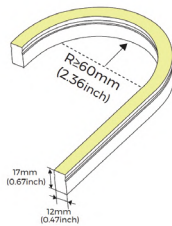

Wattage	13.2 W/m	Beam angle	N/A
Color Temperature	RGB	Lumen Output	N/A
Installation	Neon Flex Accessories Profile & Clips	Rated life hours	36000H
CRI	≥90	Colors	<input type="checkbox"/> White
Input Voltage	24V DC	Material	Neon Flex
Dimension	W 12mm x H 17mm	Cutting Section	83.3mm / 7 LEDs

Neon Flex

Side Bend

ACU ST 202203-RGBW

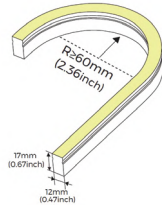

Wattage	Beam angle
---------	------------

16 W/m	N/A
--------	-----

Color Temperature

RGB-2700k RGB-4000k
RGB-3500k RGB-5000k
RGB-3000k

Installation	Rated life hours
--------------	------------------

Neon Flex Accessories Profile & Clips	36000H
---------------------------------------	--------

CRI	Colors
-----	--------

≥90	<input type="checkbox"/> White
-----	--------------------------------

Input Voltage	Material
---------------	----------

24V DC	Neon Flex
--------	-----------

Dimension	Cutting Section
-----------	-----------------

W 12mm x H 17mm	62.5mm / 12 LEDs
-----------------	------------------

ACU ST 202204-T24-4K

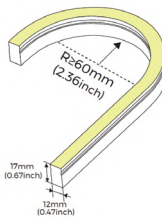

Wattage	Beam angle
---------	------------

13.2 W/m	N/A
----------	-----

Color Temperature	Lumen Output
-------------------	--------------

2400K-4000k Tunable	520 Lm/m
---------------------	----------

Installation	Rated life hours
--------------	------------------

Neon Flex Accessories Profile & Clips	36000H
---------------------------------------	--------

CRI	Colors
-----	--------

≥90	<input type="checkbox"/> White
-----	--------------------------------

Input Voltage	Material
---------------	----------

24V DC	Neon Flex
--------	-----------

Dimension	Cutting Section
-----------	-----------------

W 12mm x H 17mm	100mm / 14 LEDs
-----------------	-----------------

Neon Flex

Side Bend

ACU ST 202205

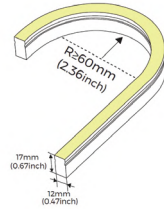

Wattage	5.8 W/m	Beam angle	N/A
Color Temperature	2700k 3000k 4000k	Lumen Output	220 Lm/m 220 Lm/m 240 Lm/m
Installation	Neon Flex Accessories Profile & Clips	Rated life hours	36000H
CRI	≥90	Colors	<input type="checkbox"/> White
Input Voltage	48V DC	Material	Neon Flex
Dimension	W 12mm x H 17mm	Cutting Section	100mm / 12 LEDs

ACU ST 202701

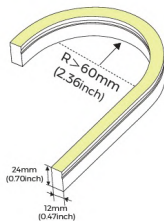

Wattage	10.6 W/m	Beam angle	N/A
Color Temperature	2700K 3000K 4000K 5000K	Lumen Output	420 Lm/m 440 Lm/m 430 Lm/m 430 Lm/m
Installation	Neon Flex Accessories Profile & Clips	Rated life hours	36000H
CRI	≥90	Colors	<input type="checkbox"/> White
Input Voltage	24V DC	Material	Neon Flex
Dimension	W 12mm x H 24mm	Cutting Section	50mm / 7 LEDs

Neon Flex

Side Bend

ACU ST 202702-RGB

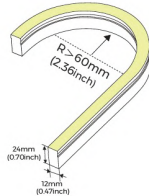

Wattage	13.2 W/m	Beam angle	N/A
Color Temperature	RGB	Lumen Output	N/A
Installation	Neon Flex Accessories Profile & Clips	Rated life hours	36000H
CRI	≥90	Colors	<input type="checkbox"/> White
Input Voltage	24V DC	Material	Neon Flex
Dimension	W 12mm x H 24mm	Cutting Section	83.3mm / 7 Leds

Neon Flex

Side Bend, Ultra Slim

ACU ST 202401

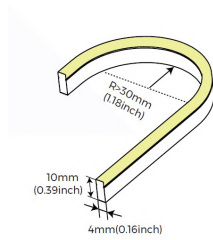

Wattage	7.9 W/m	Beam angle	N/A
Color Temperature	2300K 2700K 3000K 4000K	Lumen Output	240 Lm/m 240 Lm/m 270 Lm/m 270 Lm/m
Installation	Neon Flex Accessories Profile & Clips	Rated life hours	36000H
CRI	≥90	Colors	<input type="checkbox"/> White
Input Voltage	24V DC	Material	Neon Flex
Dimension	W 4mm x H 10mm	Cutting Section	41.66mm / 7 LEDs

Neon Flex

Side Bend, Ultra Slim

ACU ST 202402-T23-4K

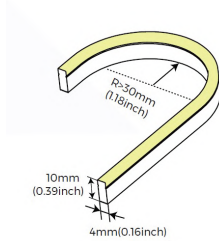

Wattage	7.9 W/m	Beam angle	N/A
Color Temperature	2300K-4000K	Lumen Output	220 Lm/m
Installation	Neon Flex Accessories Profile & Clips	Rated life hours	36000H
CRI	≥90	Colors	<input type="checkbox"/> White
Input Voltage	24V DC	Material	Neon Flex
Dimension	W 4mm x H 10mm	Cutting Section	31.25mm / 12 LEDs

ACU ST 202501

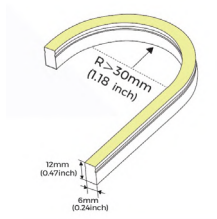

Wattage	10.6 W/m	Beam angle	N/A
Color Temperature	2300K 2700K 3000K 4000K	Lumen Output	250 Lm/m 280 Lm/m 280 Lm/m 280 Lm/m
Installation	Neon Flex Accessories Profile & Clips	Rated life hours	36000H
CRI	≥90	Colors	<input type="checkbox"/> White
Input Voltage	24V DC	Material	Neon Flex
Dimension	W 6mm x H 12mm	Cutting Section	50mm / 6 LEDs



Neon Flex

Top Bend

ACU ST 202301

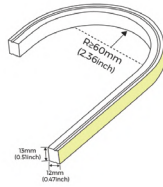

Wattage	10.6 W/m	Beam angle	N/A
Color Temperature	2700K 3000K 4000K	Lumen Output	710 Lm/m 740 Lm/m 690 Lm/m
Installation	Neon Flex Accessories Profile & Clips	Rated life hours	36000H
CRI	≥90	Colors	<input type="checkbox"/> White
Input Voltage	24V DC	Material	Neon Flex
Dimension	W 13mm x H 12mm	Cutting Section	50mm / 7 LEDs

ACU ST 202302-RGB

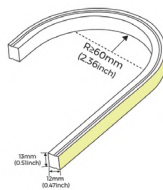

Wattage	13.2 W/m	Beam angle	N/A
Color Temperature	RGB	Lumen Output	N/A
Installation	Neon Flex Accessories Profile & Clips	Rated life hours	36000H
CRI	≥90	Colors	<input type="checkbox"/> White
Input Voltage	24V DC	Material	Neon Flex
Dimension	W 13mm x H 12mm	Cutting Section	83.3mm / 7 LEDs

Neon Flex

Top Bend

ACU ST 202303-**RGBW**

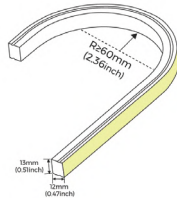

Wattage	Beam angle
16 W/m	N/A
Color Temperature	
RGB-2700K	RGB-4000K
RGB-3500K	RGB-5400K
RGB-3000K	
Installation	Rated life hours
Neon Flex Accessories Profile & Clips	36000H
CRI	Colors
≥90	<input type="checkbox"/> White
Input Voltage	Material
24V DC	Neon Flex
Dimension	Cutting Section
W 13mm x H 12mm	62.5mm / 12 LEDs

ACU ST 202304-**T27-5K**

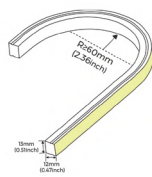

Wattage	Beam angle
13.2 W/m	N/A
Color Temperature	Lumen Output
Tunable 2700K-5000K	N/A
Installation	Rated life hours
Neon Flex Accessories Profile & Clips	36000H
CRI	Colors
≥90	<input type="checkbox"/> White
Input Voltage	Material
24V DC	Neon Flex
Dimension	Cutting Section
W 13mm x H 12mm	55.6mm / 14 LEDs

Neon Flex

Top Bend

ACU ST 202305

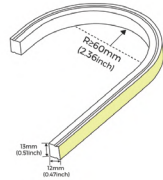

Wattage	5.8 W/m	Beam angle	N/A
Color Temperature	2700K 3000K 4000K	Lumen Output	370 Lm/m 360 Lm/m 380 Lm/m
Installation	Neon Flex Accessories Profile & Clips	Rated life hours	36000H
CRI	≥90	Colors	<input type="checkbox"/> White
Input Voltage	48V DC	Material	Neon Flex
Dimention	W 13mm x H 12mm	Cutting Section	100mm / 12 LEDs

ACU ST 202601

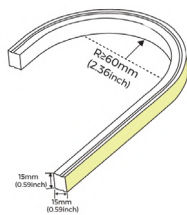

Wattage	10.6 W/m	Beam angle	N/A
Color Temperature	2200K 2700K 3000K 4000K	Lumen Output	500 Lm/m 590 Lm/m 600 Lm/m 570 Lm/m
Installation	Neon Flex Accessories Profile & Clips	Rated life hours	36000H
CRI	≥90	Colors	<input type="checkbox"/> White
Input Voltage	24V DC	Material	Neon Flex
Dimention	W 15mm x H 15mm	Cutting Section	50mm / 7 LEDs



PROJECTOR

Durable outdoor spotlight for gardens, trees and plants. Features an adjustable head, weatherproof IP65 design. Easy ground spike and surface mounted installation.



Projector

Landscape Projector

ACU OP 252501S



Wattage	Beam angle
2.6 W	20° 30°
Color Temperature	Lumen Output
3000k	92 Lm
Installation	Rated life hours
Surface Mounted	30000-50000H
CRI	Colors
≥90	■ Black
Input Voltage	Material
24V DC	Die-Casting aluminium

ACU OP 211003M

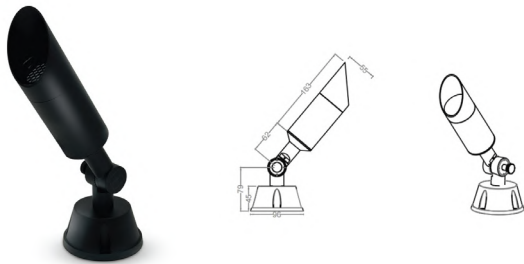

Wattage	Beam angle
6 W	15° 40°
Color Temperature	Lumen Output
3000k	540 Lm
Installation	Rated life hours
Surface Mounted	30000-50000H
CRI	Colors
≥80	■ Black
Input Voltage	Material
220V AC	Die-Casting aluminium

Projector

Landscape Projector

ACU OP 211003S

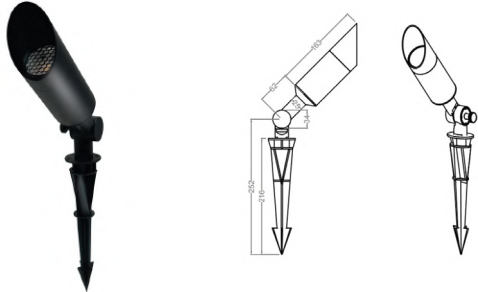

Wattage	Beam angle
6 W	15° 40°
Color Temperature	Lumen Output
3000k	540 Lm
Installation	Rated life hours
Surface Mounted	30000-50000H
CRI	Colors
≥80	■ Black
Input Voltage	Material
220V AC	Die-Casting aluminium

ACU OP 211101M

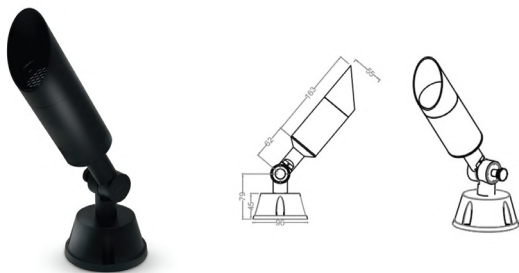

Wattage	Beam angle
12 W	15° 40°
Color Temperature	Lumen Output
3000k	1080 Lm
Installation	Rated life hours
Surface Mounted	30000-50000H
CRI	Colors
≥80	■ Black
Input Voltage	Material
220V AC	Die-Casting aluminium



Projector

Landscape Projector

ACU OP 211101S

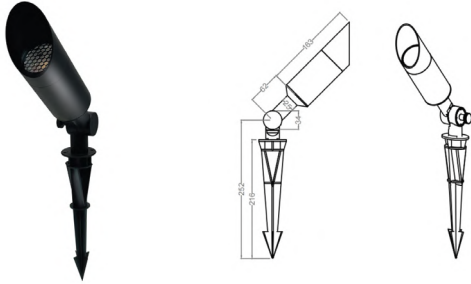

Wattage

12 W

Beam angle

15° 40°

Color Temperature

3000k

Lumen Output

1080 Lm

Installation

Planted

Rated life hours

30000-50000H

CRI

≥80

Colors

■ Black

Input Voltage

220V AC

Material

Die-Casting aluminium

ACU OP 211102M

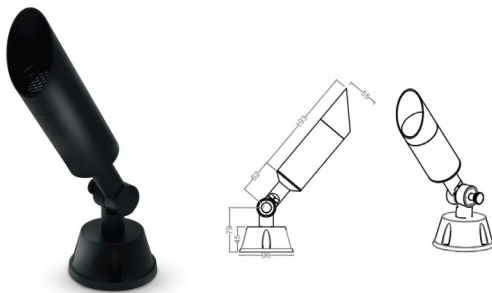

Wattage

16 W

Beam angle

15° 40°

Color Temperature

3000k

Lumen Output

1440 Lm

Installation

Surface Mounted

Rated life hours

30000-50000H

CRI

≥80

Colors

■ Black

Input Voltage

220V AC

Material

Die-Casting aluminium

Projector

Landscape Projector

ACU OP 211102S

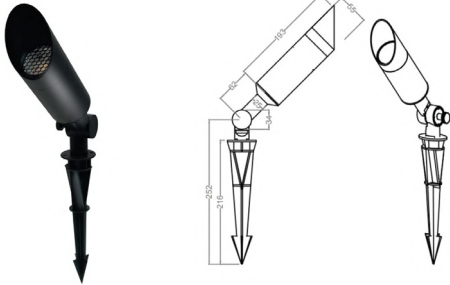

Wattage	Beam angle
16 W	15° 40°
Color Temperature	Lumen Output
3000k	1440 Lm
Installation	Rated life hours
Planted	30000-50000H
CRI	Colors
≥80	■ Black
Input Voltage	Material
220V AC	Die-Casting aluminium



Projector

Tree Ring

ACU OP 211000R

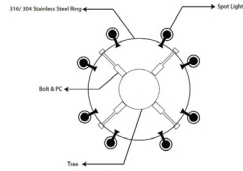

Tree Ring, Used with Tree light projectors

Diameter

600mm



BOLLARD

Modern and functional outdoor bollard light designed to illuminate pathways, gardens, driveways, and open landscapes. Offers glare-free lighting with robust construction, perfect for enhancing safety and ambience in any exterior setting.



Bollard

Landscape Light

ACU OB 182071

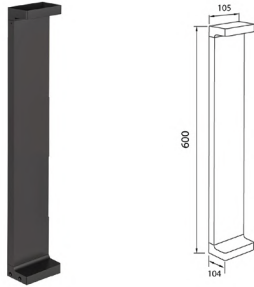

Wattage	Beam angle
5 W	Asymmetric
Color Temperature	Rated life hours
3000k	30000-50000H
Installation	Material
Floor Mounted	Aluminum + PC
CRI	Colors
≥80	■ Black
Dimension	Input Voltage
L 105.5 x W 104.5 x H 600 mm	220V AC

ACU OB 182072

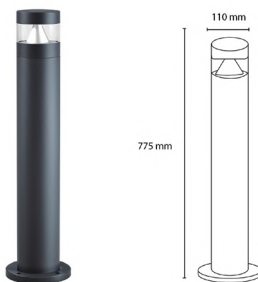

Wattage	Beam angle
7 W	120°
Color Temperature	Rated life hours
3000k	30000-50000H
Installation	Material
Floor Mounted	Aluminum + PC
CRI	Colors
≥80	■ Black
Dimension	Input Voltage
Ø110 mm, L 775 mm	220V AC

Bollard

Landscape Light

ACU OB 182073-1



Wattage

7 W

Beam angle

Asymmetric

Color Temperature

3000k

Rated life hours

30000-50000H

Installation

Floor Mounted

Material

Aluminum + PC

CRI

≥80

Colors

■ Black

Dimension

L 60 x W 120 x H 400 mm

Input Voltage

220V AC

ACU OB 182073-2

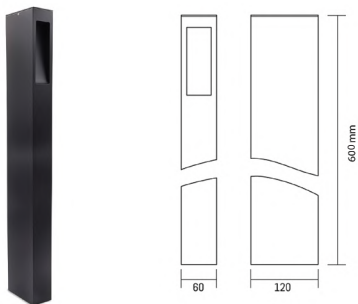

Wattage

7 W

Beam angle

Asymmetric

Color Temperature

3000k

Rated life hours

30000-50000H

Installation

Floor Mounted

Material

Aluminum + PC

CRI

≥80

Colors

■ Black

Dimension

L 60 x W 120 x H 600 mm

Input Voltage

220V AC



Bollard

Landscape Light

ACU OB 182073-3

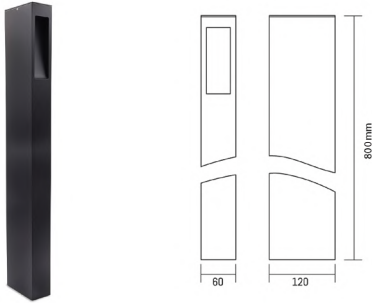

Wattage	Beam angle
7 W	Asymmetric
Color Temperature	Rated life hours
3000k	30000-50000H
Installation	Material
Floor Mounted	Aluminum + PC
CRI	Colors
≥80	■ Black
Dimension	Input Voltage
L 60 x W 120 x H 800 mm	220V AC

ACU OB 182075-1

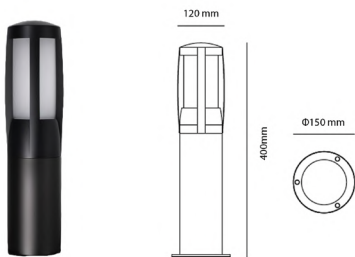

Wattage	Beam angle
8.4 W	N/A
Color Temperature	Rated life hours
3000k	30000-50000H
Installation	Material
Floor Mounted	Aluminum sheel & Glass
CRI	Colors
≥80	■ Black
Dimension	Input Voltage
Ø120 x H 400mm , Base Ø150 mm	220V AC

Bollard

Landscape Light

ACU OB 182075-2

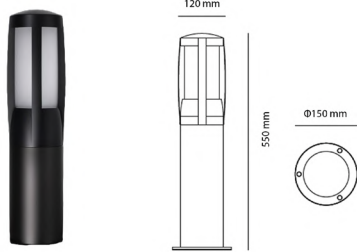

Wattage	Beam angle
16.8 W	N/A
Color Temperature	Rated life hours
3000k	30000-50000H
Installation	Material
Floor Mounted	Aluminum sheel & Glass
CRI	Colors
≥80	■ Black
Dimention	Input Voltage
Φ120 x H 550mm , Base Φ150 mm	220V AC

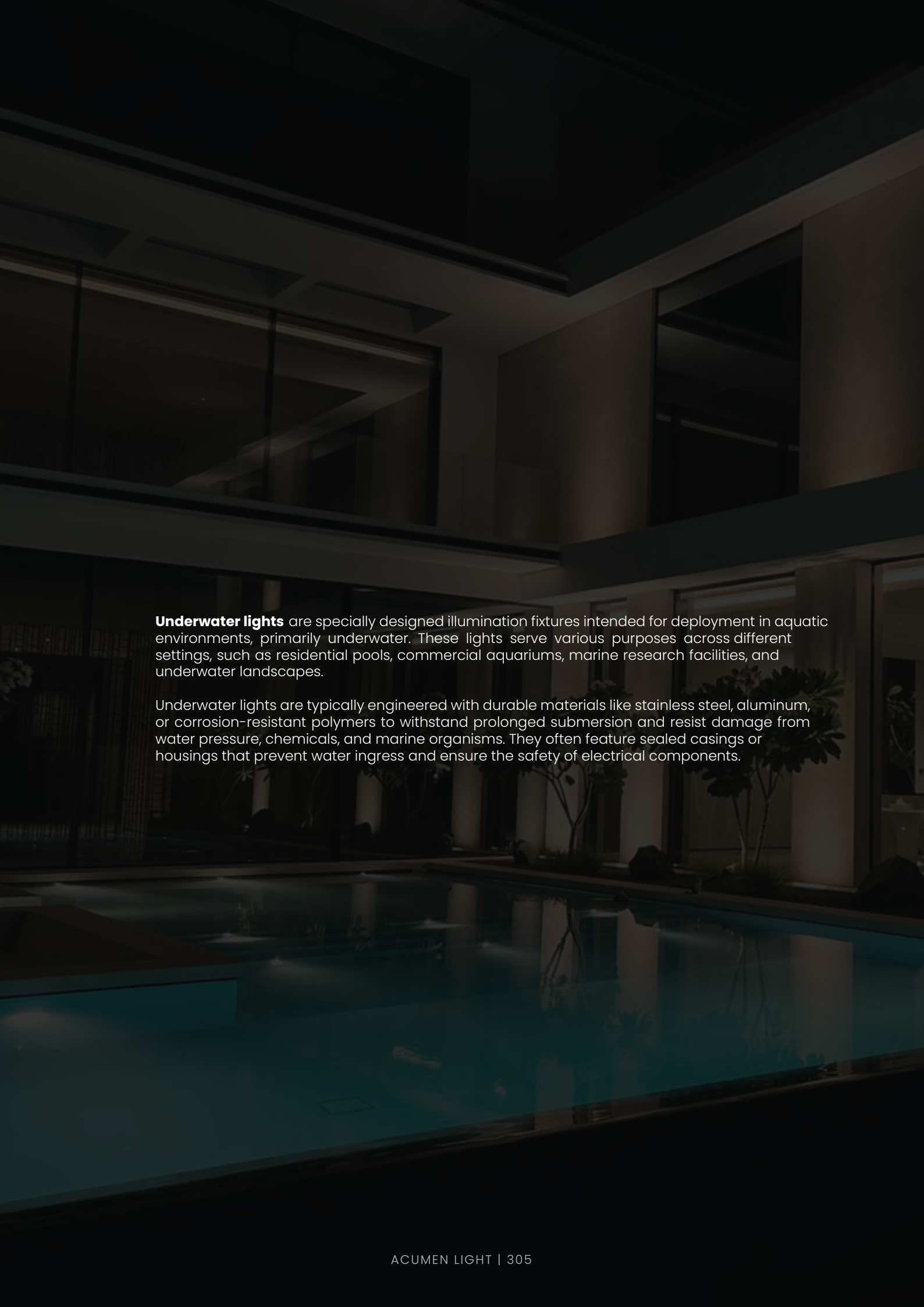

Underwater lights are specially designed illumination fixtures intended for deployment in aquatic environments, primarily underwater. These lights serve various purposes across different settings, such as residential pools, commercial aquariums, marine research facilities, and underwater landscapes.

Underwater lights are typically engineered with durable materials like stainless steel, aluminum, or corrosion-resistant polymers to withstand prolonged submersion and resist damage from water pressure, chemicals, and marine organisms. They often feature sealed casings or housings that prevent water ingress and ensure the safety of electrical components.

Spot Light

Recessed

ACU UW 208001



Wattage	Beam angle
---------	------------

1x2 W	10° 15° 30°
-------	-------------

Color Temperature	Lumen Output
-------------------	--------------

3000k	185 Lm
-------	--------

Input Voltage	Rated life hours
---------------	------------------

24V DC	30,000 - 50,000H
--------	------------------

Installation	CRI
--------------	-----

Recessed Swimming Pool	≥90
------------------------	-----

Material	Colors
----------	--------

Molding Shaped Hard Chromeplated SUS 316 Stainless Steel Housing	■ Chrome Finish
--	-----------------

ACU UW 208002

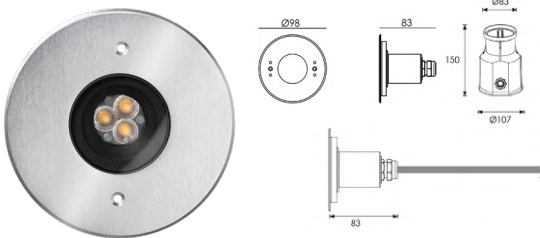

Wattage	Beam angle
---------	------------

3x2 W	30°
-------	-----

Color Temperature	Lumen Output
-------------------	--------------

3000k	443 Lm
RGBW	--

Input Voltage	Rated life hours
---------------	------------------

24V DC	30,000 - 50,000H
--------	------------------

Installation	CRI
--------------	-----

Recessed Swimming Pool	≥90
------------------------	-----

Material	Colors
----------	--------

Molding Shaped Hard Chromeplated SUS 316 Stainless Steel Housing	■ Chrome Finish
--	-----------------

Spot Light

Recessed

ACU UW 208003

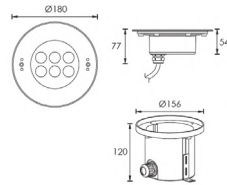

Wattage	Beam angle
---------	------------

6x2 W	15° 30°
-------	---------

Color Temperature	Lumen Output
-------------------	--------------

3000k	1230 Lm
-------	---------

Input Voltage	Rated life hours
---------------	------------------

24V DC	30,000 - 50,000H
--------	------------------

Installation	CRI
--------------	-----

Recessed Swimming Pool	≥90
------------------------	-----

Material	Colors
----------	--------

Molding Shaped Hard Chromeplated SUS 316 Stainless Steel Housing	■ Chrome Finish
--	-----------------

ACU UW 208004

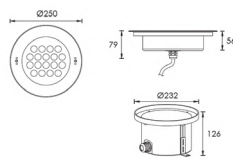

Wattage	Beam angle
---------	------------

18x2 W	30°
--------	-----

Color Temperature	Lumen Output
-------------------	--------------

3000k	2310 Lm
RGBW	--

Input Voltage	Rated life hours
---------------	------------------

24V DC	30,000 - 50,000H
--------	------------------

Installation	CRI
--------------	-----

Recessed Swimming Pool	≥90
------------------------	-----

Material	Colors
----------	--------

Molding Shaped Hard Chromeplated SUS 316 Stainless Steel Housing	■ Chrome Finish
--	-----------------

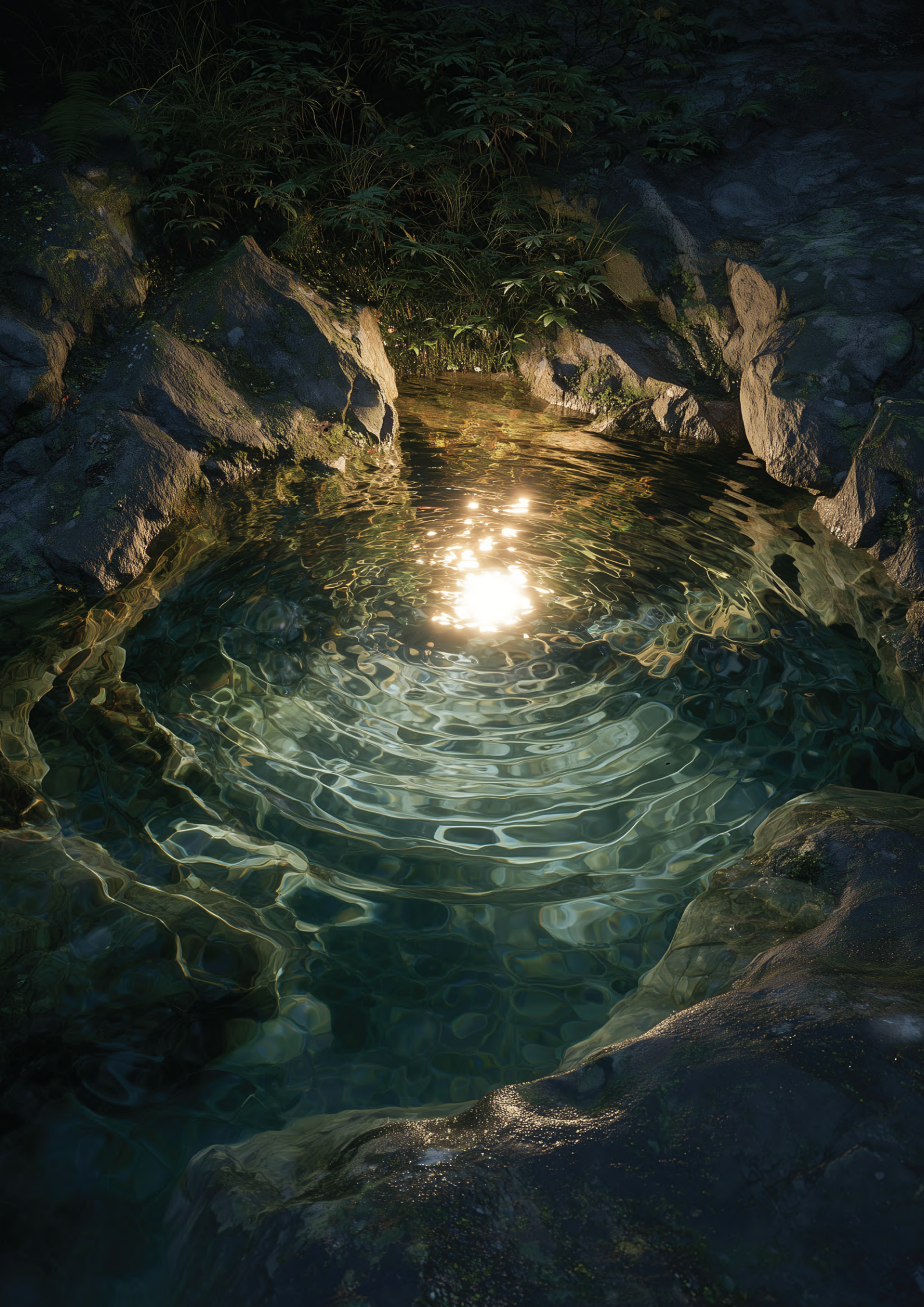

Linear

Recessed

ACU UW 208005

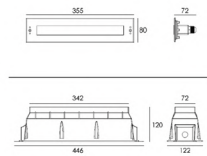

Wattage	Beam angle
---------	------------

6x3 W	13° 30°
-------	---------

Color Temperature	Lumen Output
-------------------	--------------

3000k	1324 Lm/m
RGBW	--

Input Voltage	Rated life hours
---------------	------------------

24V DC	30,000 - 50,000H
--------	------------------

Installation	CRI
--------------	-----

Recessed Swimming Pool	≥90
------------------------	-----

Material	Colors
----------	--------

Molding Shaped Hard Chromeplated SUS 316 Stainless Steel Housing	■ Chrome Finish
--	-----------------

Spot Light

Recessed

ACU UW 208006

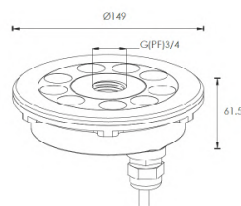

Wattage	Beam angle
---------	------------

12x2 W	30°
--------	-----

Color Temperature	Lumen Output
-------------------	--------------

3000k	1610 Lm
-------	---------

Input Voltage	Rated life hours
---------------	------------------

24V DC	30,000 - 50,000H
--------	------------------

Installation	CRI
--------------	-----

Recessed Swimming Pool	≥90
------------------------	-----

Material	Colors
----------	--------

Molding Shaped Hard Chromeplated SUS 316 Stainless Steel Housing	■ Chrome Finish
--	-----------------

Spot Light

Recessed

ACU UW 208007

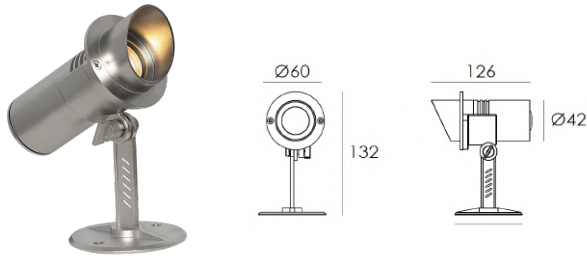

Wattage	Beam angle
---------	------------

3x2 W	30°
-------	-----

Color Temperature	Lumen Output
-------------------	--------------

3000k	322 Lm
-------	--------

Input Voltage	Rated life hours
---------------	------------------

24V DC	30,000 - 50,000H
--------	------------------

Installation	CRI
--------------	-----

Surface Mounted	≥90
-----------------	-----

Material	Colors
----------	--------

Hard Chromeplated Stainless Steel	■ Chrome Finish
--------------------------------------	-----------------

ACU UW 208008

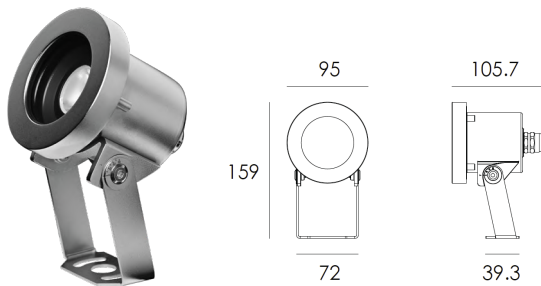

Wattage	Beam angle
---------	------------

3x2 W	20°
-------	-----

Color Temperature	Lumen Output
-------------------	--------------

3000k	1182 Lm
-------	---------

Input Voltage	Rated life hours
---------------	------------------

24V DC	30,000 - 50,000H
--------	------------------

Installation	CRI
--------------	-----

Surface Mounted	≥90
-----------------	-----

Material	Colors
----------	--------

Molding Shaped Hard Chromeplated SUS 316 Stainless Steel Housing	■ Chrome Finish
--	-----------------

Spot Light

Surface Mounted

ACU UW 208009

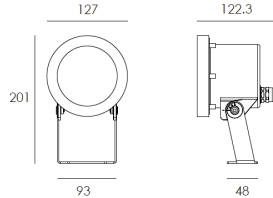

Wattage	Beam angle
---------	------------

6x3 W	30°
-------	-----

Color Temperature	Lumen Output
-------------------	--------------

3000k	1575 Lm
-------	---------

Input Voltage	Rated life hours
---------------	------------------

24V DC	30,000 - 50,000H
--------	------------------

Installation	CRI
--------------	-----

Surface Mounted	≥90
-----------------	-----

Material	Colors
----------	--------

Molding Shaped Hard Chromeplated SUS 316 Stainless Steel Housing	■ Chrome Finish
--	-----------------

ACU UW 208010

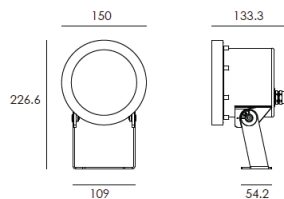

Wattage	Beam angle
---------	------------

6x4.5 W	9° 15° 45° 60°
---------	----------------

Color Temperature	Lumen Output
-------------------	--------------

3000k	2908 Lm
-------	---------

Input Voltage	Rated life hours
---------------	------------------

24V DC	30,000 - 50,000H
--------	------------------

Installation	CRI
--------------	-----

Surface Mounted	≥90
-----------------	-----

Material	Colors
----------	--------

Molding Shaped Hard Chromeplated SUS 316 Stainless Steel Housing	■ Chrome Finish
--	-----------------



UNDERWATER **NEONFLEX**



Neonflex

Side Bend

ACU UW 202900S

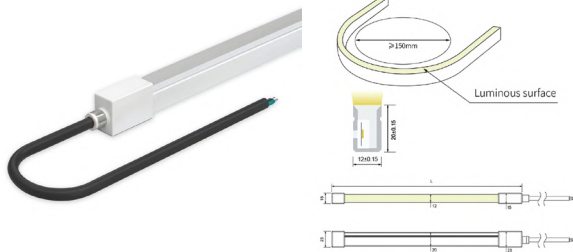

Wattage	5W/m	Beam angle	120°
Color Temperature	3000k	Lumen Output	185 Lm/m
Installation	Neon Flex Accessories (Mounting Clips, PC Profile, Aluminum Profile)	Rated life hours	30000-50000H
CRI	≥90	Colors	<input type="checkbox"/> White
Input Voltage	24V DC	Material	Dow Chemical SILASTIC and Silicone Rubber
Cutting Section	Unit Length 50mm	Bending	Side Bend

ACU UW 202901S

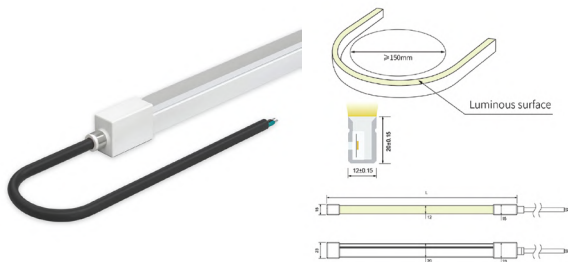

Wattage	10W/m	Beam angle	120°
Color Temperature	2700k, 3000k, 4000k	Lumen Output	370 Lm/m
Installation	Neon Flex Accessories (Mounting Clips, PC Profile, Aluminum Profile)	Rated life hours	30000-50000H
CRI	≥90	Colors	<input type="checkbox"/> White
Input Voltage	24V DC	Material	Dow Chemical SILASTIC and Silicone Rubber
Cutting Section	Unit Length 50mm	Bending	Side Bend



Neonflex

Side Bend

ACU UW 202902S

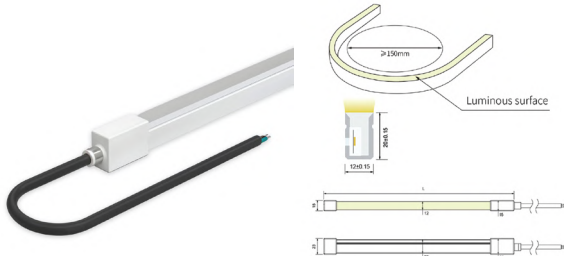

Wattage	15W/m	Beam angle	120°
Color Temperature	2700k, 3000k	Lumen Output	555 Lm/m
Installation	Neon Flex Accessories (Mounting Clips, PC Profile, Aluminum Profile)	Rated life hours	30000-50000H
CRI	≥90	Colors	<input type="checkbox"/> White
Input Voltage	24V DC	Material	Dow Chemical SILASTIC and Silicone Rubber
Cutting Section	Unit Length 50mm	Bending	Side Bend

Neonflex

Top Bend

ACU UW 202900T



Wattage	5W/m	Beam angle	120°
Color Temperature	3000k	Lumen Output	185 Lm/m
Installation	Neon Flex Accessories (Mounting Clips, PC Profile, Aluminum Profile)	Rated life hours	30000-50000H
CRI	≥90	Colors	<input type="checkbox"/> White
Input Voltage	24V DC	Material	Dow Chemical SILASTIC and Silicone Rubber
Cutting Section	Unit Length 50mm	Bending	Top Bend

Neonflex

Underwater outdoor

ACU UW 202901T

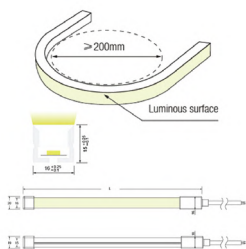

Wattage	10W/m	Beam angle	120°
Color Temperature	3000k	Lumen Output	370 Lm/m
Installation	Neon Flex Accessories (Mounting Clips, PC Profile, Aluminum Profile)	Rated life hours	30000-50000H
CRI	≥90	Colors	<input type="checkbox"/> White
Input Voltage	24V DC	Material	Dow Chemical SILASTIC and Silicone Rubber
Cutting Section	Unit Length 50mm	Bending	Top Bend

ACU UW 202902T

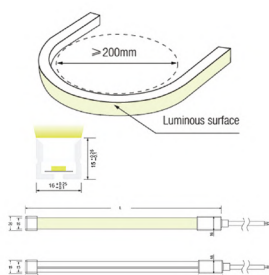

Wattage	15W/m	Beam angle	120°
Color Temperature	2700K, 3000k	Lumen Output	555 Lm/m
Installation	Neon Flex Accessories (Mounting Clips, PC Profile, Aluminum Profile)	Rated life hours	30000-50000H
CRI	≥90	Colors	<input type="checkbox"/> White
Input Voltage	24V DC	Material	Dow Chemical SILASTIC and Silicone Rubber
Cutting Section	Unit Length 50mm	Bending	Top Bend

