

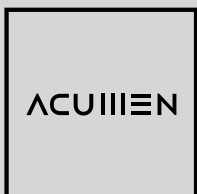

Wall & Stair Light

Outdoor Lighting



Wall & Stair light outdoor series create a welcoming atmosphere by highlighting features of a building or structure. A variety of shapes and styles contribute to the overall architectural design of the building

Wall & Stair

ACU OSR 182036

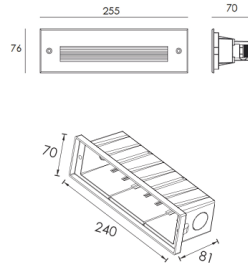

Wattage	5.7W	Beam Angle	N/A
Color Temperature	3000k	Lumen Output	≈104 Lm
Installation	Recessed	Rated Life Hours	30,000 - 50,000H
CRI	≥90	Colors	■ Grey
Input Voltage	220V AC (with the Attached Built in Driver)	Materials	Die Casting Powder Coated Aluminum.

ACU OSR 182037

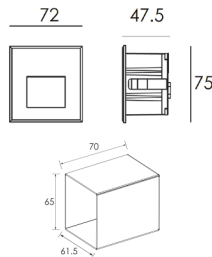

Wattage	3x0.7W	Beam Angle	120°
Color Temperature	3000k	Lumen Output	≈36 Lm
Installation	Recessed Inground	Rated Life Hours	30,000 - 50,000H
CRI	≥90	Colors	■ Black □ White ■ Grey
Input Voltage	220V AC (with the Attached Built in Driver)	Materials	Die Casting Powder Coated Aluminum.

Wall & Stair

ACU OSR 182038

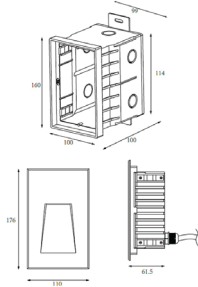

Wattage	18x0.2W	Beam Angle	120°
Color Temperature	3000k	Lumen Output	≈85 Lm
Installation	Recessed	Rated Life Hours	30,000 - 50,000H
CRI	≥90	Colors	■ Black ■ Grey
Input Voltage	220V AC (with the Attached Built in Driver)	Materials	Die Casting Powder Coated Aluminum.

ACU OSR 182039

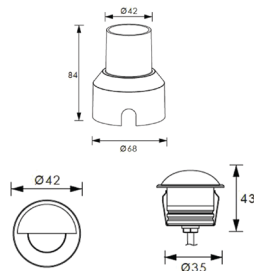

Wattage	1x1W	Beam Angle	32°
Color Temperature	3000k	Lumen Output	≈23 Lm
Installation	Recessed Inground	Rated Life Hours	30,000 - 50,000H
CRI	≥90	Colors	■ Grey
Input Voltage	24V DC	Materials	Die Casting Powder Coated Aluminum.

Wall & Stair

ACU OSR 182040

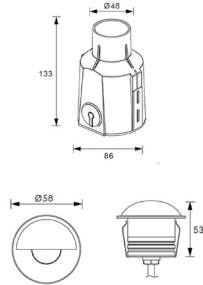

Wattage	Beam Angle
1x2W	22°
Color Temperature	Lumen Output
3000k	≈51 Lm
Installation	Rated Life Hours
Recessed	30,000 - 50,000H
CRI	Colors
≥90	■ Grey
Input Voltage	Materials
24V DC	Die Casting Powder Coated Aluminum.

ACU OSR 182041

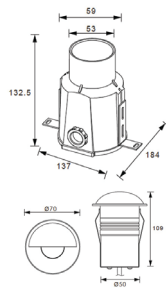

Wattage	Beam Angle
1x5W	18° 24° 32°
Color Temperature	Lumen Output
3000k	≈208 Lm
Installation	Rated Life Hours
Recessed	30,000 - 50,000H
CRI	Colors
≥90	■ Grey
Input Voltage	Materials
24V DC	Die Casting Powder Coated Aluminum.



Wall & Stair

ACU OSR 216001

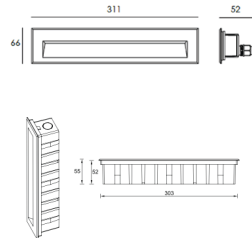

Wattage	Beam Angle
---------	------------

30x0.3W	N/A
---------	-----

Color Temperature	Lumen Output
-------------------	--------------

3000k	≈400 Lm
-------	---------

Installation	Rated Life Hours
--------------	------------------

Wall Mounted	30,000 - 50,000H
--------------	------------------

CRI	Colors
-----	--------

≥90	■ Grey
-----	--------

Input Voltage	Materials
---------------	-----------

220V AC (with the Attached Built in Driver)	Die-casting Aluminum
--	-------------------------

ACU OSR 216002

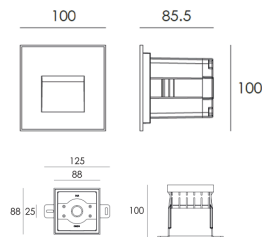

Wattage	Beam Angle
---------	------------

10x0.5W	N/A
---------	-----

Color Temperature	Lumen Output
-------------------	--------------

3000k	≈112 Lm
-------	---------

Installation	Rated Life Hours
--------------	------------------

Wall Mounted	30,000 - 50,000H
--------------	------------------

CRI	Colors
-----	--------

≥90	■ Grey
-----	--------

Input Voltage	Materials
---------------	-----------

220V AC (with the Attached Built in Driver)	Die-casting Aluminum
--	-------------------------

Wall & Stair

ACU OSR 216003R

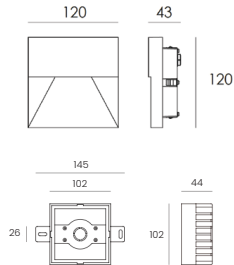
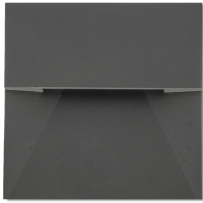

Wattage	Beam Angle
9x0.5W	N/A
Color Temperature	Lumen Output
3000k	≈158 Lm
Installation	Rated Life Hours
Wall Mounted	30,000 - 50,000H
CRI	Colors
≥90	■ Grey
Input Voltage	Materials
220V AC (with the Attached Built in Driver)	Die-casting Aluminum

ACU OSM 216003S

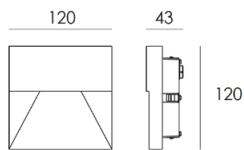
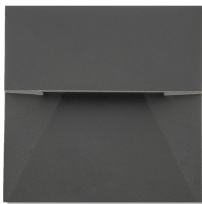

Wattage	Beam Angle
9x0.5W	N/A
Color Temperature	Lumen Output
3000k	≈158 Lm
Installation	Rated Life Hours
Wall Mounted	30,000 - 50,000H
CRI	Colors
≥90	■ Grey
Input Voltage	Materials
220V AC (with the Attached Built in Driver)	Die-casting Aluminum



Wall & Stair

ACU OSR 216004

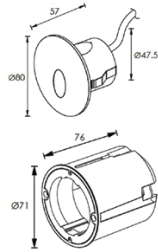

Wattage	Beam Angle
1W	80°
Color Temperature	Lumen Output
3000k	≈46 Lm
Installation	Rated Life Hours
Wall Mounted	30,000 - 50,000H
CRI	Colors
≥90	■ Grey
Input Voltage	Materials
220V AC (with the Attached Built in Driver)	Stainless Steel Cover with Matt Cover

ACU OSR 216005

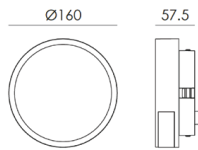

Wattage	Beam Angle
12x0.5W	N/A
Color Temperature	Lumen Output
3000k	≈127Lm
Installation	Rated Life Hours
Wall Mounted	30,000 - 50,000H
CRI	Colors
≥90	■ Grey
Input Voltage	Materials
220V AC (with the Attached Built in Driver)	Die-casting Aluminum

Wall & Stair

ACU OW 182042

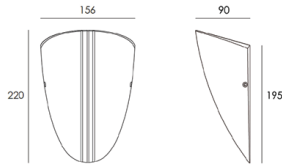

Wattage	Beam Angle
1x6W	10°
1x12W	25°
Color Temperature	Lumen Output
3000k	≈44 Lm
Installation	Rated Life Hours
Wall Mounted	30,000 - 50,000H
CRI	Colors
≥90	■ Black ■ Grey
Input Voltage	Materials
220V AC (with the Attached Built in Driver)	Stainless Steel Cover with Matt Cover

ACU OW 182043

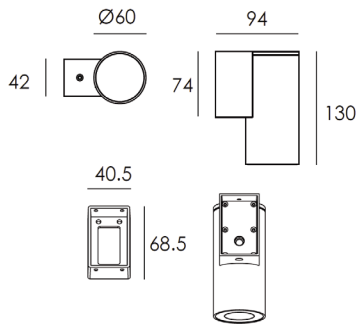

Wattage	Beam Angle
1x4.5W	15° 24° 38°
Color Temperature	Lumen Output
3000k	≈282Lm
Installation	Rated Life Hours
Wall Mounted	30,000 - 50,000H
CRI	Colors
≥90	■ Grey
Input Voltage	Materials
220V AC (with the Attached Built in Driver)	Die Casting Powder Coated Aluminum

Wall & Stair

ACU OW 182044

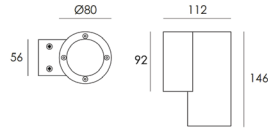

Wattage	Beam Angle
---------	------------

1x10W	15° 24° 38° 60°
-------	-----------------

Color Temperature	Lumen Output
-------------------	--------------

3000k	≈1170 Lm
-------	----------

Installation	Rated Life Hours
--------------	------------------

Wall Mounted	30,000 - 50,000H
--------------	------------------

CRI	Colors
-----	--------

≥90	■ Grey
-----	--------

Input Voltage	Materials
---------------	-----------

220V AC (with the Attached Built in Driver)	Die Casting Powder Coated Aluminum
--	---------------------------------------

ACU OW 182045

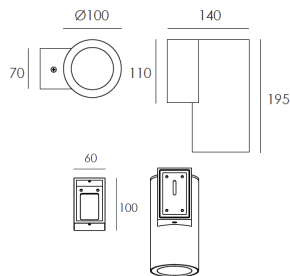

Wattage	Beam Angle
---------	------------

1x18W	12° 22° 38° 55°
-------	-----------------

Color Temperature	Lumen Output
-------------------	--------------

3000k	≈1847Lm
-------	---------

Installation	Rated Life Hours
--------------	------------------

Wall Mounted	30,000 - 50,000H
--------------	------------------

CRI	Colors
-----	--------

≥90	■ Grey
-----	--------

Input Voltage	Materials
---------------	-----------

220V AC (with the Attached Built in Driver)	Die Casting Powder Coated Aluminum
--	---------------------------------------



Wall & Stair

ACU OW 182046

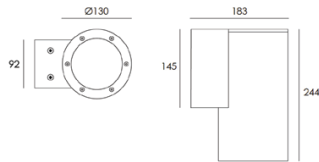

Wattage	Beam Angle
1x25W	10° 22° 38°
Color Temperature	Lumen Output
3000k	≈2967 Lm
Installation	Rated Life Hours
Wall Mounted	30,000 - 50,000H
CRI	Colors
≥90	■ Grey
Input Voltage	Materials
220V AC (with the Attached Built in Driver)	Die Casting Powder Coated Aluminum

ACU OW 182047

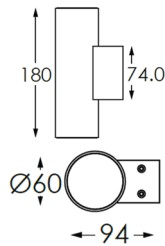

Wattage	Beam Angle
2x4.5W	15° 24° 38°
Color Temperature	Lumen Output
3000k	254x2Lm
Installation	Rated Life Hours
Wall Mounted	30,000 - 50,000H
CRI	Colors
≥90	■ Black ■ Grey
Input Voltage	Materials
220V AC (with the Attached Built in Driver)	Die Casting Powder Coated Aluminum



Wall & Stair

ACU OW 182048

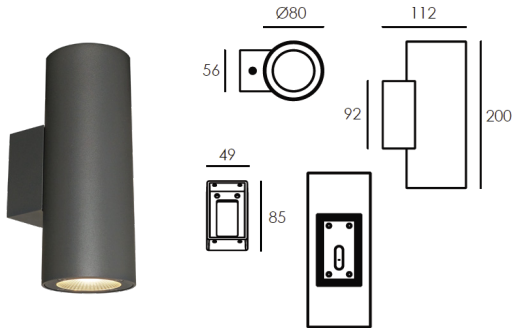

Wattage	Beam Angle
2X8W	15° 24° 38° 60°
Color Temperature	Lumen Output
3000k	≈1972 Lm
Installation	Rated Life Hours
Wall Mounted	30,000 - 50,000H
CRI	Colors
≥90	■ Grey
Input Voltage	Materials
220V AC (with the Attached Built in Driver)	Die Casting Powder Coated Aluminum

ACU OW 182049

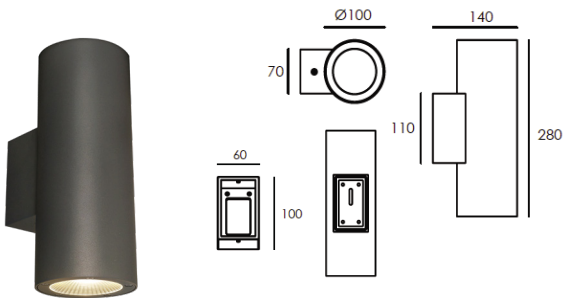

Wattage	Beam Angle
2X12W	12° 22° 38° 55°
Color Temperature	Lumen Output
3000k	≈2158Lm
Installation	Rated Life Hours
Wall Mounted	30,000 - 50,000H
CRI	Colors
≥90	■ Grey
Input Voltage	Materials
220V AC (with the Attached Built in Driver)	Die Casting Powder Coated Aluminum

Wall & Stair

ACU OW 182050

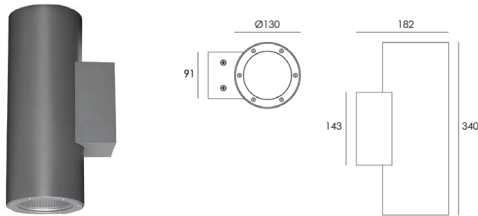

Wattage	Beam Angle
2x18W	10° 22° 38°
Color Temperature	Lumen Output
3000k	≈4072 Lm
Installation	Rated Life Hours
Wall Mounted	30,000 - 50,000H
CRI	Colors
≥90	■ Grey
Input Voltage	Materials
220V AC (with the Attached Built in Driver)	Die Casting Powder Coated Aluminum

ACU OW 182051

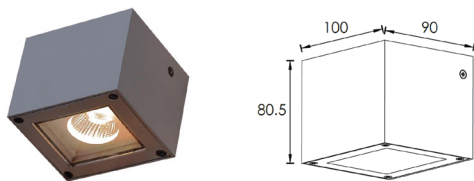

Wattage	Beam Angle
1x6W	18° 25° 40°
Color Temperature	Lumen Output
3000k	≈651 Lm
Installation	Rated Life Hours
Wall Mounted	30,000 - 50,000H
CRI	Colors
≥90	■ Black □ White ■ Grey
Input Voltage	Materials
220V AC (with the Attached Built in Driver)	Die Casting Powder Coated Aluminum.

Wall & Stair

ACU OW 182051N

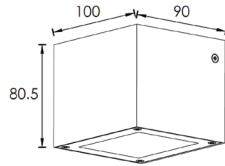
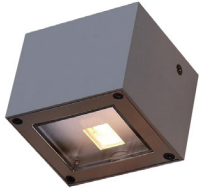

Wattage	Beam Angle
1x3W	10°
Color Temperature	Lumen Output
3000k	≈68 Lm
Installation	Rated Life Hours
Wall Mounted	30,000 - 50,000H
CRI	Colors
≥90	■ Black ■ Grey
Input Voltage	Materials
220V AC (with the Attached Built in Driver)	Die Casting Powder Coated Aluminum

ACU OW 182052

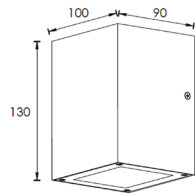

Wattage	Beam Angle
2x6W	18° 25° 40°
Color Temperature	Lumen Output
3000k	≈13021 Lm
Installation	Rated Life Hours
Wall Mounted	30,000 - 50,000H
CRI	Colors
≥90	■ Grey
Input Voltage	Materials
220V AC (with the Attached Built in Driver)	Die Casting Powder Coated Aluminum

Wall & Stair

ACU OW 182052N

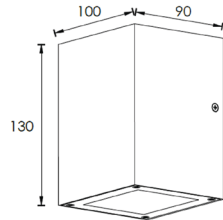

Wattage	Beam Angle
2x3W	10°
Color Temperature	Lumen Output
3000k	≈69 Lm
Installation	Rated Life Hours
Wall Mounted	30,000 - 50,000H
CRI	Colors
≥90	■ Black □ White ■ Grey
Input Voltage	Materials
220V AC (with the Attached Built in Driver)	Die Casting Powder Coated Aluminum.

