

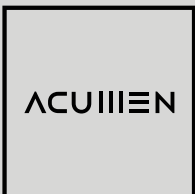

PONTO

Indoor Lighting



PONTO Featuring a unified base, effortless installation, and a diverse range that blends general, accent & decorative lighting.

Ponto stands out as the ultimate lighting solution.

Ponto Base

Trimless

ACU BS 240000T

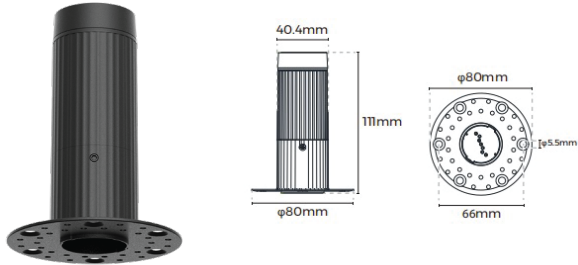

Wattage	Rated Current
150W	3A
CutOut	Maximum load
φ45mm	8Kg
Warranty	Colors
5 years	■ Black □ White
Installation	Input voltage
Trimless Recessed Mounted	24V DC (Via the External Driver)

Ponto Base

Recessed

ACU BS 240000R

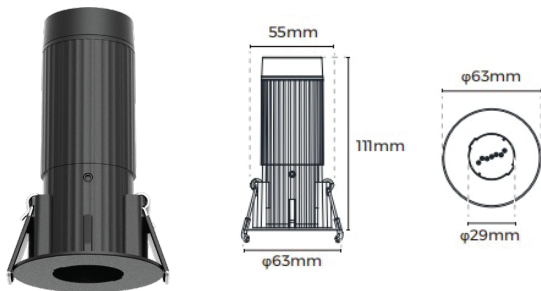

Wattage	Rated Current
150W	3A
CutOut	Maximum load
φ55mm	1Kg
Warranty	Colors
5 years	■ Black □ White
Installation	Input voltage
Recessed	24V DC (Via the External Driver)

PONTO SPOT LIGHT

Fixed

ACU PS 241000

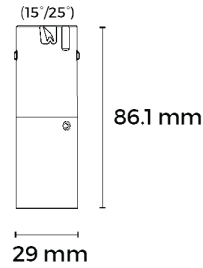

Wattage	Beam Angle
3W	15° 25°
Color Temperature	Lumen Output
3000k	126 Lm
Installation	Rated Life Hours
Mounted on a Common Base	30,000 - 50,000H
CRI	Colors
≥90	■ Black
Input Voltage	Materials
24V DC (Via the External Driver)	Powder Coated Aluminum.

Adjustable

ACU PTS 241001

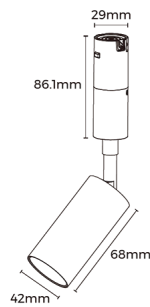

Wattage	Beam Angle
6W	24° 36°
Color Temperature	Lumen Output
3000k	451 Lm
Installation	Rated Life Hours
Mounted on a Common Base	30,000 - 50,000H
CRI	Colors
≥90	■ Black
Input Voltage	Materials
24V DC (Via the External Driver)	Powder Coated Aluminum.

PONTO SPOT LIGHT

Adjustable

ACU PTS 241002

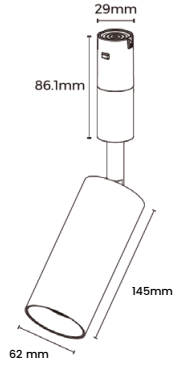

Wattage	Beam Angle
14W	15° 24°
Color Temperature	Lumen Output
3000k	1057 Lm
Installation	Rated Life Hours
Mounted on a Common Base	30,000 - 50,000H
CRI	Colors
≥90	■ Black
Input Voltage	Materials
24V DC (Via the External Driver)	Powder Coated Aluminum.



PONTO ZOOMABLE LIGHT

ACU PTZ 241101

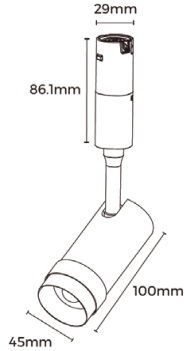

Wattage	Beam Angle
5W	12° 50°
Color Temperature	Lumen Output
3000k	329 Lm
Installation	Rated Life Hours
Mounted on a Common Base	30,000 - 50,000H
CRI	Colors
≥90	■ Black
Input Voltage	Materials
24V DC (Via the External Driver)	Powder Coated Aluminum.

ACU PTZ 241102

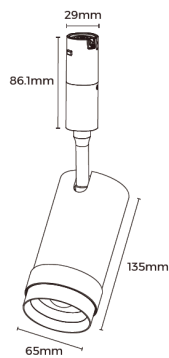

Wattage	Beam Angle
12W	15° 36°
Color Temperature	Lumen Output
3000k	878 Lm
Installation	Rated Life Hours
Mounted on a Common Base	30,000 - 50,000H
CRI	Colors
≥90	■ Black
Input Voltage	Materials
24V DC (Via the External Driver)	Powder Coated Aluminum.

Round Tube



Asymmetric



Double asymmetric



Wall Washer



Prismatic



Grating



Diffuser



PONTO LINEAR

ROUND TUBE LIGHT

ACU PTL 241201

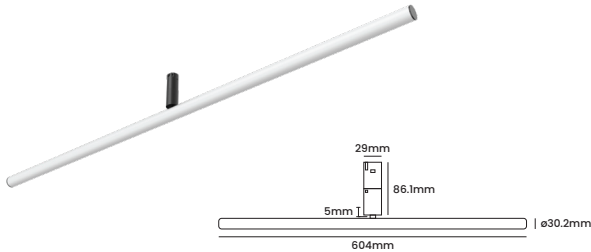

Wattage	Beam Angle
12W	200° x 110°
Color Temperature	Lumen Output
3000k	1128 Lm
Installation	Rated Life Hours
Mounted on a Common Base	30,000 - 50,000H
CRI	Colors
≥90	<input type="checkbox"/> White
Input Voltage	Materials
24V DC (Via the External Driver)	Powder Coated Aluminum.

ACU PTL 241202

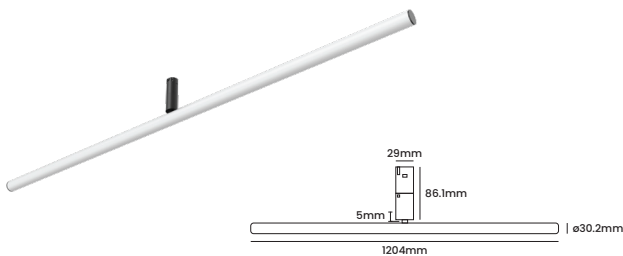

Wattage	Beam Angle
24W	200° x 110°
Color Temperature	Lumen Output
3000k	2256 Lm
Installation	Rated Life Hours
Mounted on a Common Base	30,000 - 50,000H
CRI	Colors
≥90	<input type="checkbox"/> White
Input Voltage	Materials
24V DC (Via the External Driver)	Powder Coated Aluminum.

PONTO LINEAR

Normal Diffuser

ACU PTL 241301

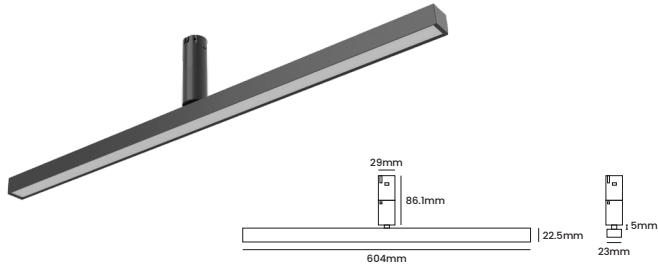

Wattage	Beam Angle
12W	110°
Color Temperature	Lumen Output
3000k	846 Lm
Installation	Rated Life Hours
Mounted on a Common Base	30,000 - 50,000H
CRI	Colors
≥90	■ Black
Input Voltage	Materials
24V DC (Via the External Driver)	Powder Coated Aluminum.

ACU PTL 241302

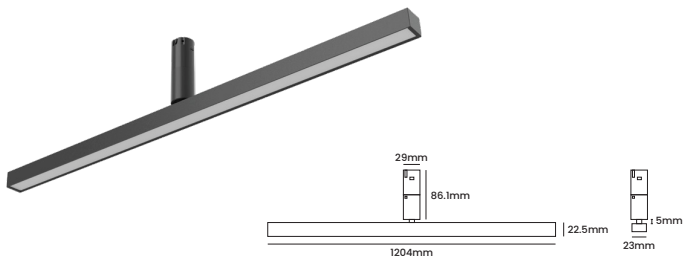

Wattage	Beam Angle
24W	110°
Color Temperature	Lumen Output
3000k	1692 Lm
Installation	Rated Life Hours
Mounted on a Common Base	30,000 - 50,000H
CRI	Colors
≥90	■ Black
Input Voltage	Materials
24V DC (Via the External Driver)	Powder Coated Aluminum.

PONTO LINEAR

Normal Diffuser

ACU PTL 241801

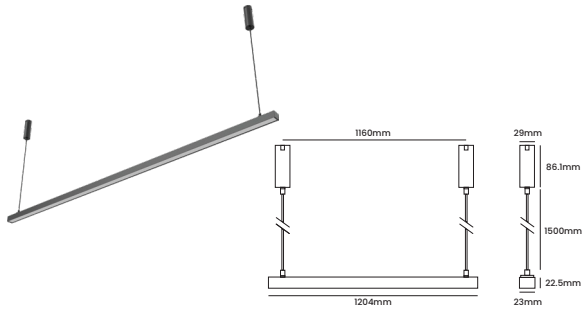

Wattage	Beam Angle
24W	110°
Color Temperature	Lumen Output
3000k	1692 Lm
Installation	Rated Life Hours
Mounted on a Common Base	30,000 - 50,000H
CRI	Colors
≥90	■ Black
Input Voltage	Materials
24V DC (Via the External Driver)	Powder Coated Aluminum.

PONTO LINEAR

Prismatic Diffuser

ACU PTL 241401

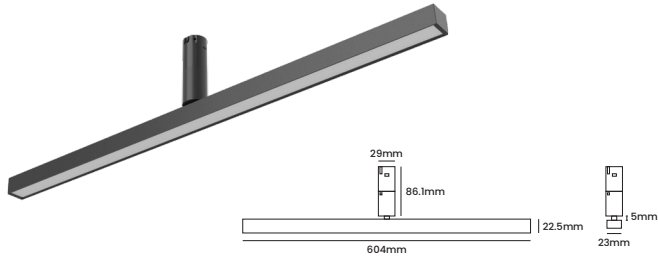

Wattage	Beam Angle
12W	70°
Color Temperature	Lumen Output
3000k	846 Lm
Installation	Rated Life Hours
Mounted on a Common Base	30,000 - 50,000H
CRI	Colors
≥90	■ Black
Input Voltage	Materials
24V DC (Via the External Driver)	Powder Coated Aluminum.

ACU PTL 241402

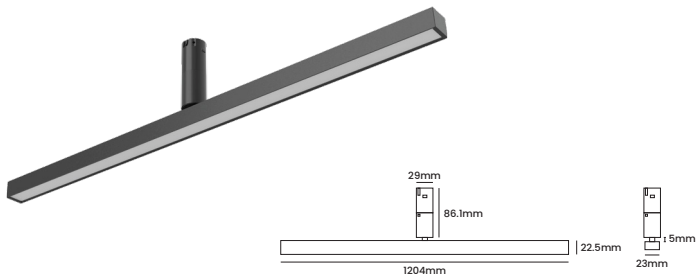

Wattage	Beam Angle
24W	70°
Color Temperature	Lumen Output
3000k	1692 Lm
Installation	Rated Life Hours
Mounted on a Common Base	30,000 - 50,000H
CRI	Colors
≥90	■ Black
Input Voltage	Materials
24V DC (Via the External Driver)	Powder Coated Aluminum.

PONTO LINEAR

Prismatic Diffuser

ACU PTL 241901

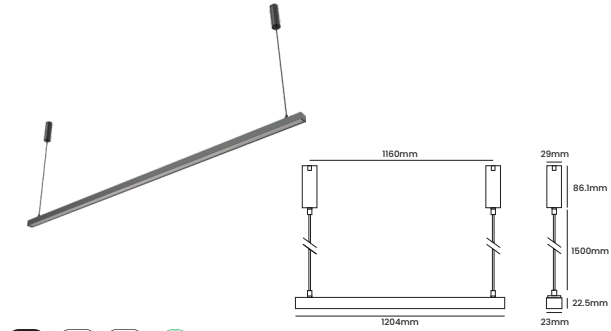

Wattage	Beam Angle
---------	------------

24W	70°
-----	-----

Color Temperature	Lumen Output
-------------------	--------------

3000k	1800 Lm
-------	---------

Installation	Rated Life Hours
--------------	------------------

Mounted on a Common Base	30,000 - 50,000H
--------------------------	------------------

CRI	Colors
-----	--------

≥90	■ Black
-----	---------

Input Voltage	Materials
---------------	-----------

24V DC (Via the External Driver)	Powder Coated Aluminum.
-------------------------------------	----------------------------

PONTO LINEAR

Grating Diffuser

ACU PTL 241501

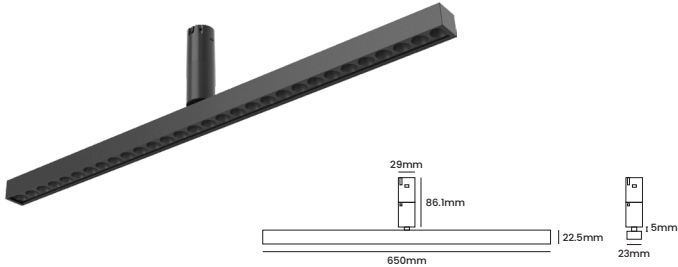

Wattage	Beam Angle
13W	30°
Color Temperature	Lumen Output
3000k	858 Lm
Installation	Rated Life Hours
Mounted on a Common Base	30,000 - 50,000H
CRI	Colors
≥90	■ Black
Input Voltage	Materials
24V DC (Via the External Driver)	Powder Coated Aluminum.

ACU PTL 241502

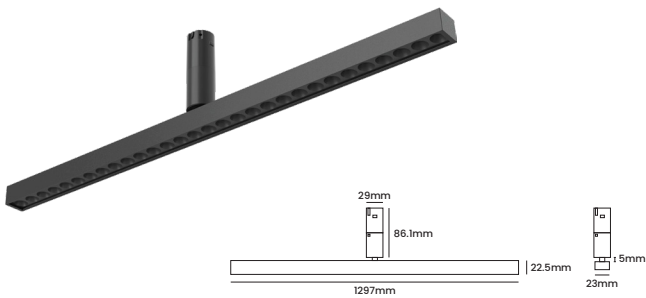

Wattage	Beam Angle
26W	30°
Color Temperature	Lumen Output
3000k	1716 Lm
Installation	Rated Life Hours
Mounted on a Common Base	30,000 - 50,000H
CRI	Colors
≥90	■ Black
Input Voltage	Materials
24V DC (Via the External Driver)	Powder Coated Aluminum.

PONTO LINEAR

Grating Diffuser

ACU PTL 242001

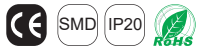
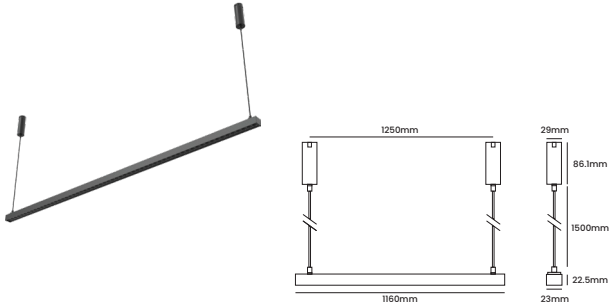

Wattage

26W

Beam Angle

30°

Color Temperature

3000k

Lumen Output

1710 Lm

Installation

On Recessed Base

Rated Life Hours

30,000 - 50,000H

CRI

≥90

Colors

■ Black

Input Voltage

24V DC
(Via the External Driver)

Materials

Powder Coated
Aluminum.

PONTO LINEAR

Asymmetric Diffuser

ACU PTL 241601

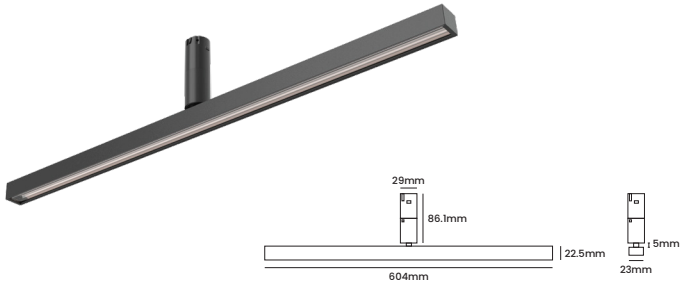

Wattage	Beam Angle
12W	90° x 45° x 15°
Color Temperature	Lumen Output
3000k	1128 Lm
Installation	Rated Life Hours
Mounted on a Common Base	30,000 - 50,000H
CRI	Colors
≥90	■ Black
Input Voltage	Materials
24V DC (Via the External Driver)	Powder Coated Aluminum.

ACU PTL 241602

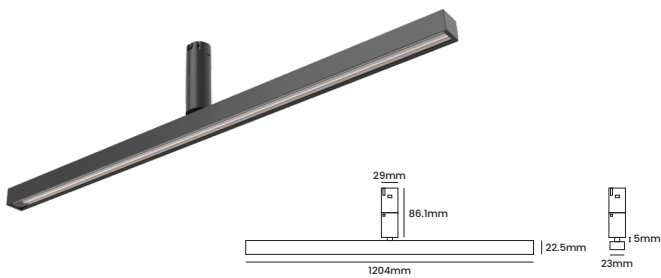

Wattage	Beam Angle
24W	90° x 45° x 15°
Color Temperature	Lumen Output
3000k	2256 Lm
Installation	Rated Life Hours
Mounted on a Common Base	30,000 - 50,000H
CRI	Colors
≥90	■ Black
Input Voltage	Materials
24V DC (Via the External Driver)	Powder Coated Aluminum.

PONTO LINEAR

Double Asymmetric Diffuser

ACU PTL 241701

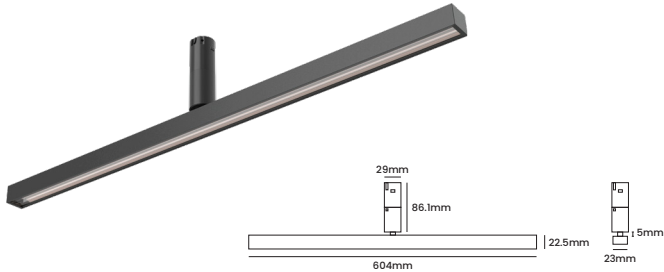

Wattage	Beam Angle
12W	100° x 90° x 15°
Color Temperature	Lumen Output
3000k	1128 Lm
Installation	Rated Life Hours
Mounted on a Common Base	30,000 - 50,000H
CRI	Colors
≥90	■ Black
Input Voltage	Materials
24V DC (Via the External Driver)	Powder Coated Aluminum.

ACU PTL 241702

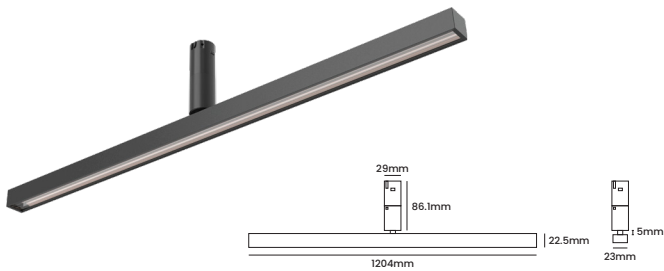

Wattage	Beam Angle
24W	100° x 90° x 15°
Color Temperature	Lumen Output
3000k	2256 Lm
Installation	Rated Life Hours
Mounted on a Common Base	30,000 - 50,000H
CRI	Colors
≥90	■ Black
Input Voltage	Materials
24V DC (Via the External Driver)	Powder Coated Aluminum.



UP-DOWN LINEAR LIGHT

Normal Diffuser

ACU PTL 242101

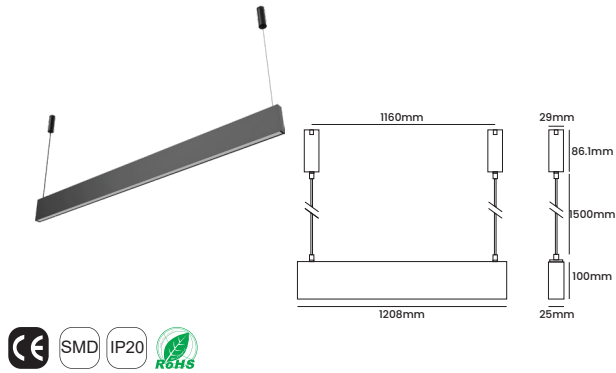

Wattage	Beam Angle
48W	Up: 100° , Down: 100°
Color Temperature	Lumen Output
3000k	2707 Lm
Installation	Rated Life Hours
Mounted on a Common Base	30,000 - 50,000H
CRI	Colors
≥90	■ Black
Input Voltage	Materials
24V DC (Via the External Driver)	Powder Coated Aluminum.

UP-DOWN PONTO LINEAR LIGHT

Prismatic Diffuser

ACU PTL 242201

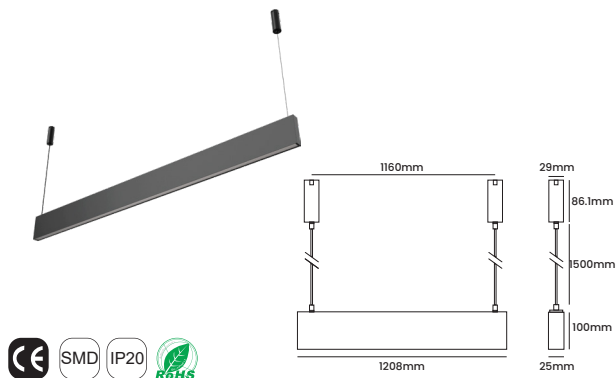

Wattage	Beam Angle
48W	Up: 100° , Down: 100°
Color Temperature	Lumen Output
3000k	2797 Lm
Installation	Rated Life Hours
Mounted on a Common Base	30,000 - 50,000H
CRI	Colors
≥90	■ Black
Input Voltage	Materials
24V DC (Via the External Driver)	Powder Coated Aluminum.

UP-DOWN PONTO LINEAR LIGHT

Grating Diffuser

ACU PTL 242301

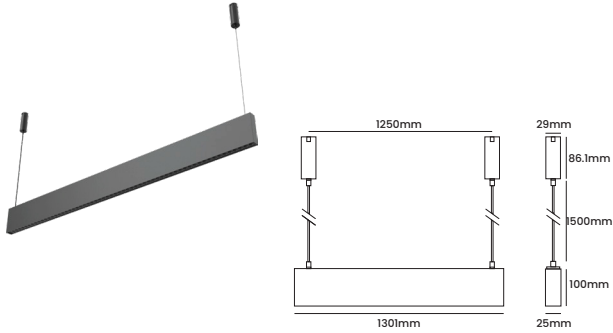

Wattage

53W

Beam Angle

Up:100° , Down: 100°

Color Temperature

3000k

Lumen Output

2571 Lm

Installation

Mounted on a Common Base

Rated Life Hours

30,000 - 50,000H

CRI

≥90

Colors

■ Black

Input Voltage

24V DC
(Via the External Driver)

Materials

Powder Coated
Aluminum.

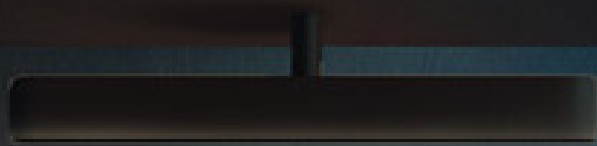

PONTO WALL WASHER

ACU WW 242401

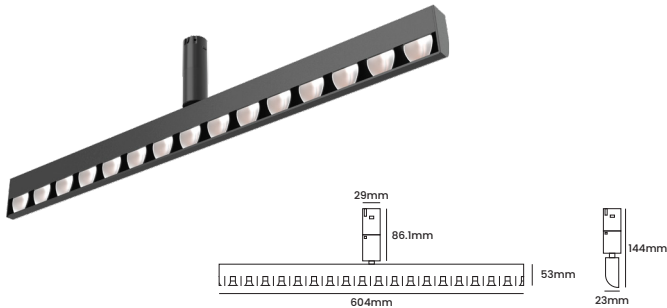

Wattage	Beam Angle
10W	60° X 25° X 73°
Color Temperature	Lumen Output
3000k	846 Lm
Installation	Rated Life Hours
On Recessed Base	30,000 - 50,000H
CRI	Colors
≥90	■ Black
Input Voltage	Materials
24V DC (Via the External Driver)	Powder Coated Aluminum.

ACU WW 242402

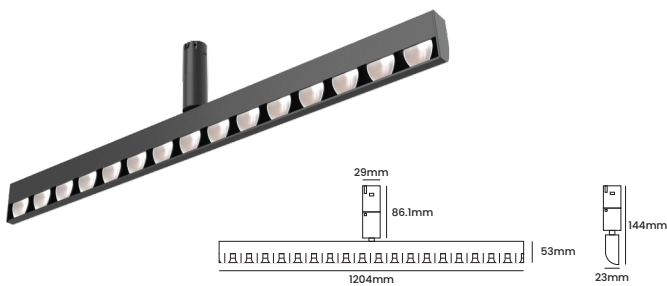

Wattage	Beam Angle
20W	60° X 25° X 73°
Color Temperature	Lumen Output
3000k	1692 Lm
Installation	Rated Life Hours
On Recessed Base	30,000 - 50,000H
CRI	Colors
≥90	■ Black
Input Voltage	Materials
24V DC (Via the External Driver)	Powder Coated Aluminum.



Round Neon Flex

ACU WW 242501

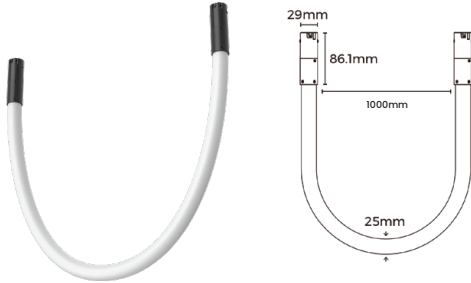

Wattage	Beam Angle
14W	360°
Color Temperature	Lumen Output
3000k	920 Lm
Installation	Rated Life Hours
Mounted on a Common Base	30,000 - 50,000H
CRI	Colors
≥90	<input type="checkbox"/> White
Input Voltage	Materials
24V DC (Via the External Driver)	Silicon Neon Flex.

ACU WW 242502

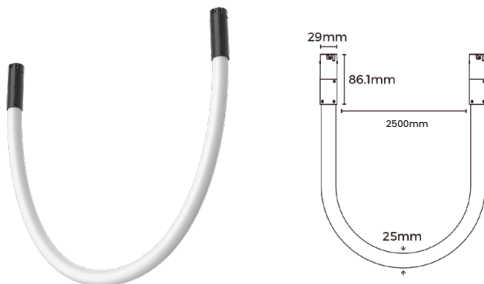

Wattage	Beam Angle
35W	360°
Color Temperature	Lumen Output
3000k	2300 Lm
Installation	Rated Life Hours
Mounted on a Common Base	30,000 - 50,000H
CRI	Colors
≥90	<input type="checkbox"/> White
Input Voltage	Materials
24V DC (Via the External Driver)	Silicon Neon Flex.

Round Neon Flex

ACU WW 242503

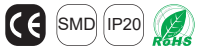
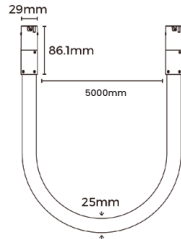

Wattage	Beam Angle
---------	------------

70W	360°
-----	------

Color Temperature	Lumen Output
-------------------	--------------

3000k	4600 Lm
-------	---------

Installation	Rated Life Hours
--------------	------------------

Mounted on a Common Base	30,000 - 50,000H
--------------------------	------------------

CRI	Colors
-----	--------

≥90	<input type="checkbox"/> White
-----	--------------------------------

Input Voltage	Materials
---------------	-----------

24V DC (Via the External Driver)	Silicon Neon Flex.
-------------------------------------	--------------------

PONTO DECORATIVE

ACU PTD 242601

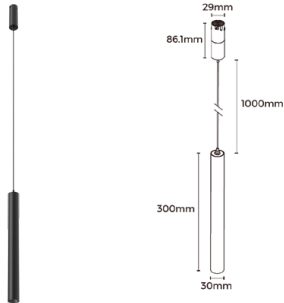

Wattage	Beam Angle
6W	24°
Color Temperature	Lumen Output
3000k	370 Lm
Installation	Rated Life Hours
Mounted on a Common Base	30,000 - 50,000H
CRI	Colors
≥90	■ Black
Input Voltage	Materials
24V DC (Via the External Driver)	Powder Coated Aluminum.

ACU PTD 242602

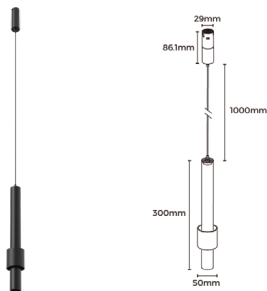

Wattage	Beam Angle
6W	24°
Color Temperature	Lumen Output
3000k	370 Lm
Installation	Rated Life Hours
Mounted on a Common Base	30,000 - 50,000H
CRI	Colors
≥90	■ Black
Input Voltage	Materials
24V DC (Via the External Driver)	Powder Coated Aluminum.



PONTO DECORATIVE

Neon Flex

ACU PTD 242603

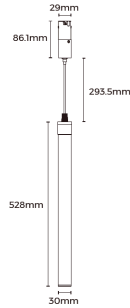

Wattage	Beam Angle
7W	360°
Color Temperature	Lumen Output
3000k	460 Lm
Installation	Rated Life Hours
Mounted on a Common Base	30,000 - 50,000H
CRI	Colors
≥90	■ Black
Input Voltage	Materials
24V DC (Via the External Driver)	Silicon Neon Flex.

ACU PTD 242604

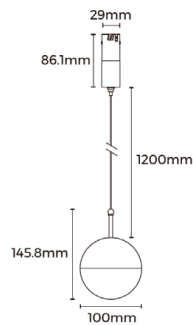

Wattage	Beam Angle
6W	360°
Color Temperature	Lumen Output
3000k	560 Lm
Installation	Rated Life Hours
Mounted on a Common Base	30,000 - 50,000H
CRI	Colors
≥90	■ Black
Input Voltage	Materials
24V DC (Via the External Driver)	Powder Coated Aluminum.



PONTO DECORATIVE

Water Drop

ACU PTD 242605

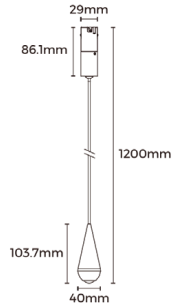

Wattage	Beam Angle
4W	110°
Color Temperature	Lumen Output
3000k	340 Lm
Installation	Rated Life Hours
Mounted on a Common Base	30,000 - 50,000H
CRI	Colors
≥90	■ Black
Input Voltage	Materials
24V DC (Via the External Driver)	Silicon Neon Flex.

Sunset

ACU PTD 242606

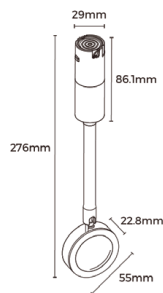

Wattage	Beam Angle
3W	110°
Color Temperature	Lumen Output
3000k	170 Lm
Installation	Rated Life Hours
Mounted on a Common Base	30,000 - 50,000H
CRI	Colors
≥90	■ Black
Input Voltage	Materials
24V DC (Via the External Driver)	Powder Coated Aluminum.



